

SERVICE MANUAL

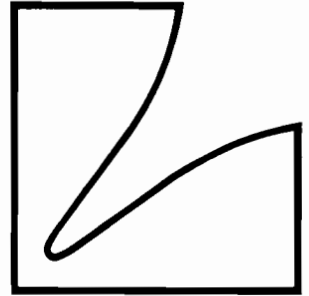

System Remote Control Center

U-100

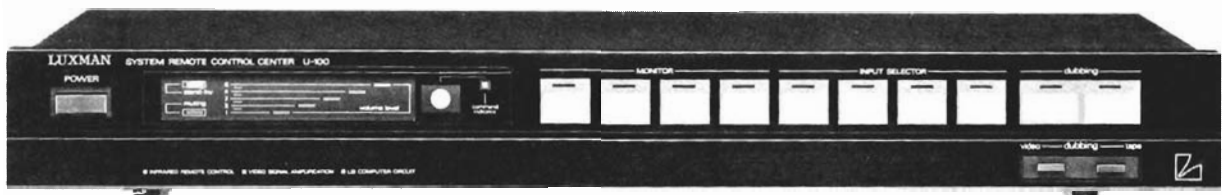

Contents

Specifications	2
Parts Locations and Disassembly Instructions	3 to 5
Block Diagram	6
Schematic Diagram	7 to 9
Parts Layout on P.C. Board and Wiring Diagram	10 to 12
Electrical Parts List	13 to 16
Parts List by the Destination	17
Cabinet Assembly Parts List	18
Exploded View (Cabinet)	19 to 20
Packing Assembly Parts List	21
Packing Method View.	21
Semi-Conductor Lead Identifications	22 to 26

Specifications

Distortion

Output 2V Input/CD: 20 ~ 20 kHz	0.1%
Output 150mV Input/CD: 20 ~ 20 kHz	0.05%

Input Impedance

CD, TUNER, LINE/PHONO, AV TAPE 1, TAPE 2, VIDEO 1, VIDEO 2 (STEREO)	45K +15%
---	----------

Frequency Response

CD, TUNER, LINE/PHONO, AV, TAPE 1, TAPE 2, VIDEO 1, VIDEO 2	10 Hz ~ 100 kHz \pm 1/3 dB
---	------------------------------

Noise Level (Input Open)

CD, TUNER, LINE/PHONO, AV, TAPE 1, TAPE 2, VIDEO 1, VIDEO 2	8 dB
---	------

Signal to Noise Ratio (INPUT SHORT)

CD, TUNER, LINE/PHONO, AV TAPE 1, TAPE 2, VIDEO 1, VIDEO 2

A) Input Level: 150mV	80 dB
B) Input Level: 2V	100 dB

Residual Noise

CD	10 μ V
--------------	------------

Cross Talk (INPUT SHORTED 150mV)

CD, TUNER, LINE/PHONO, AV, TAPE 1, TAPE 2, VIDEO 1, VIDEO 2: 10 kHz.	50 dB
--	-------

Power Supply	AC 100/120/220/240V, 50/60 Hz (AD model only)
	AC 120V, 60 Hz (UQ and UZ model only)

Power Consumption.	15W
----------------------------	-----

Semiconductors	18 IC's, 35 Transistors, 19 Diodes, 1 Bridge Diode
--------------------------	--

Dimension	438(W) x 58(H) x 240(D) mm
---------------------	----------------------------

Weight.	2.5 kg
-----------------	--------

Parts Locations and Disassembly Instructions

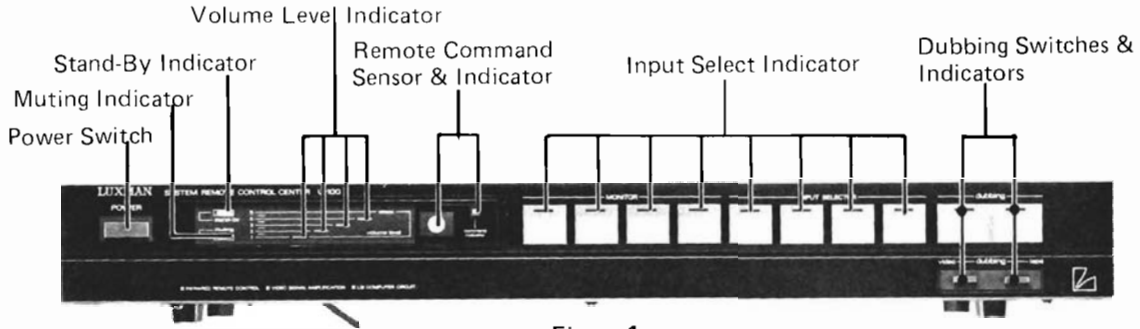

Figure 1

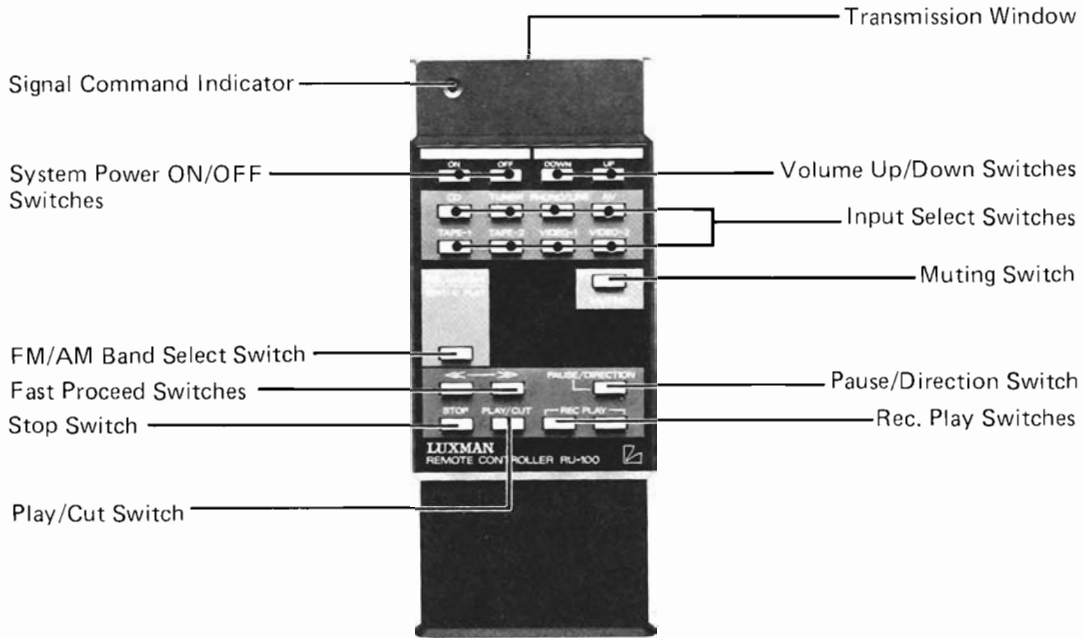

Figure 2

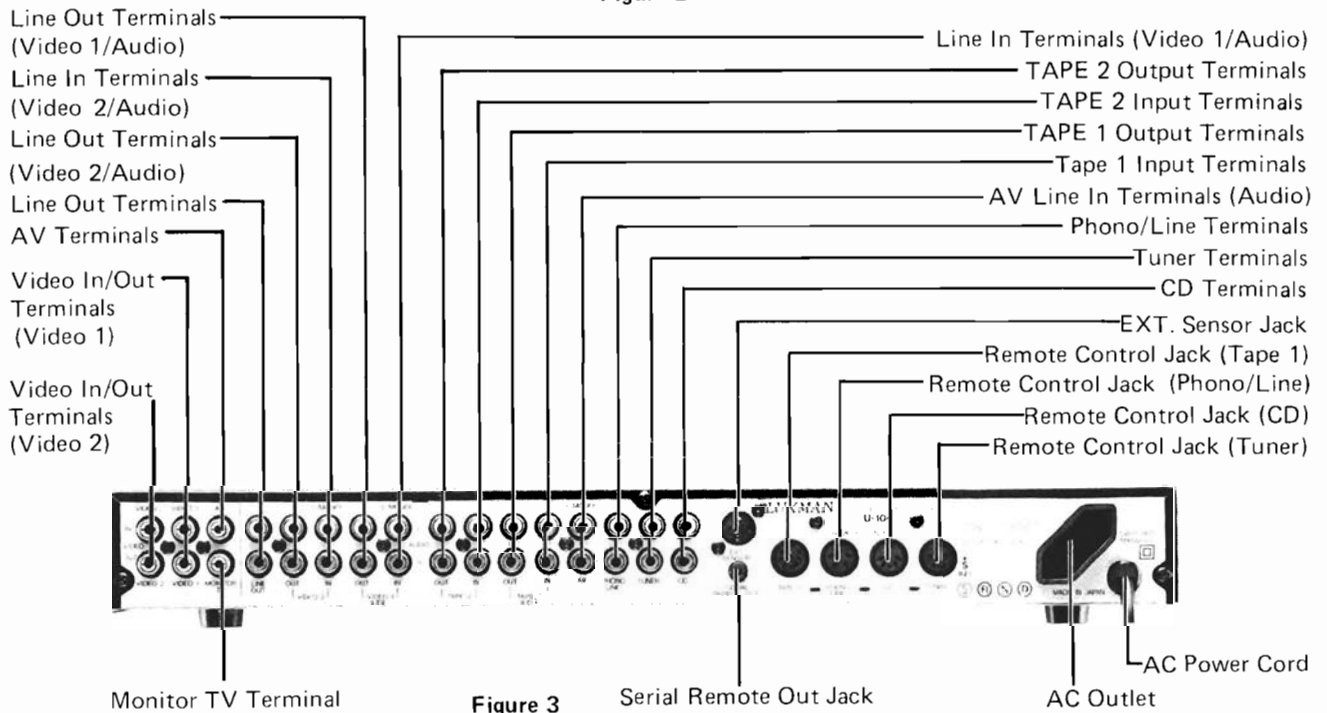

Figure 3

1. Removal of Top Cover

- (1) Remove seven screws marked "○" as shown in Figures 4, 5 and 6.
- (2) Pull out the top cover in the arrow direction as shown in Figure 4.

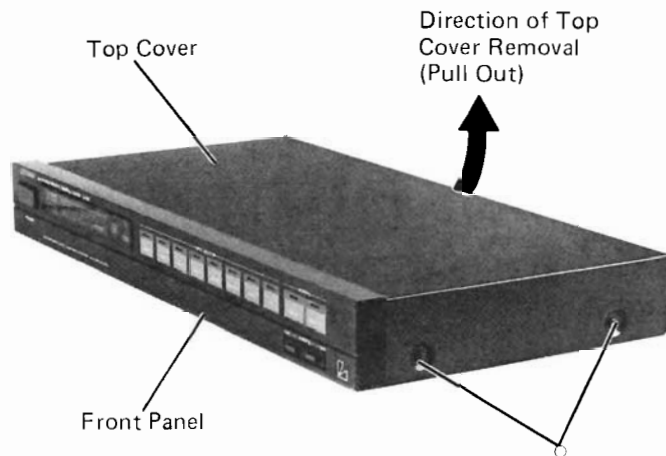

Figure 4

2. Removal of Front Panel

- (1) Remove three screws marked "△" as shown in Figure 5.
- (2) Push lightly forward the front panel by inserting a slotted-head driver near three hooks (a) between the panel and the front chassis as shown in Figure 7. The front panel can be removed.

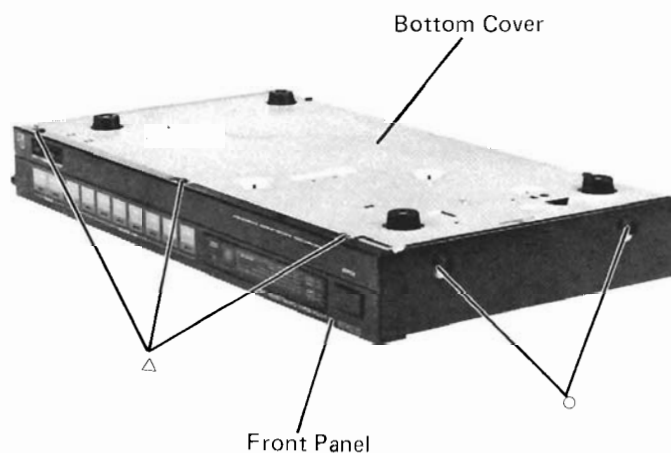

Figure 5

3. Removal of Front Chassis

- (1) After removal of the front panel remove four screws marked "◇" as shown in Figure 8.
- (2) The front chassis can be removed completely with Panel Side Frames (L)/(R), Power Switch P.C. Board, Remote P.C. Board and Display P.C. Board. Remove respective P.C. Boards as mentioned in the following instructions.

4. Removal of Power Switch P.C. Board, Remote P.C. Board and Display P.C. Board

- (1) Remove three screws marked "◆", and hooks (b) as shown in Figures 8 and 10.
- (2) Disconnect all wires from these P.C. Boards.

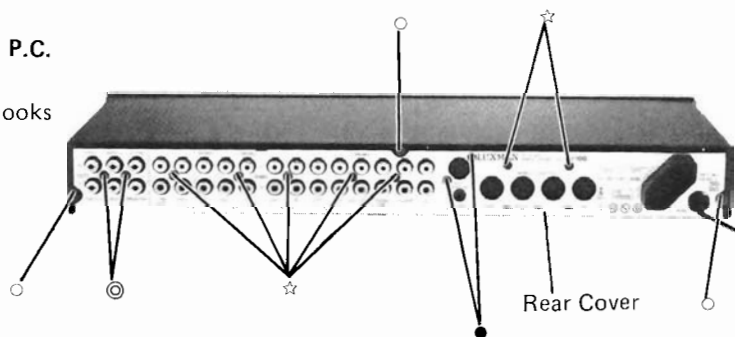

Figure 6

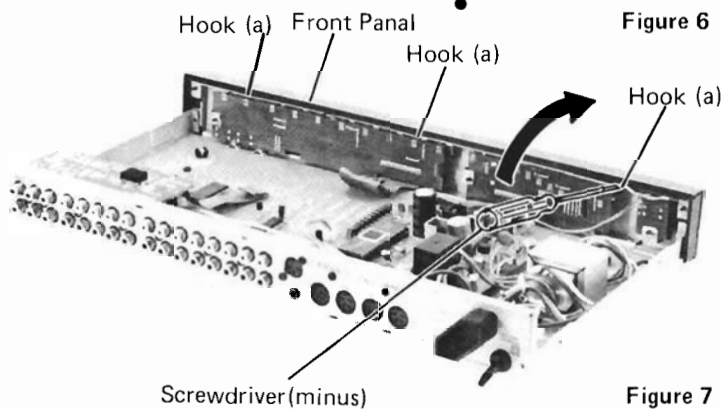

Figure 7

5. Removal of DIN Jack P.C. Board

- (1) Remove two screws marked "●" as shown in Figure 6.
- (2) Disconnect the wire from the DIN Jack P.C. Board as shown in Figure 9.

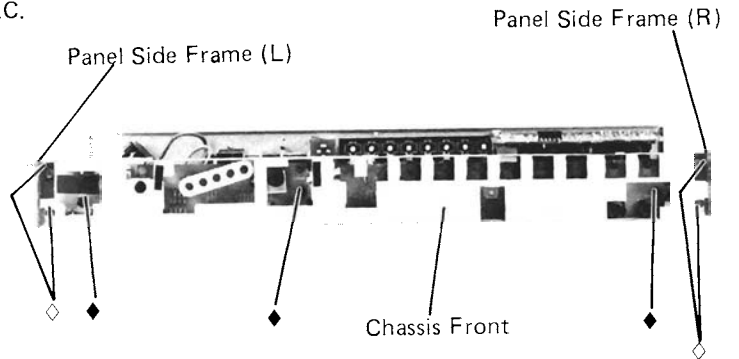

Figure 8

6. Removal of Video P.C. Board

- (1) Remove two screws marked "◎" as shown in Figure 6.
- (2) Disconnect the wire from the Video P.C. Board as shown in Figure 9.

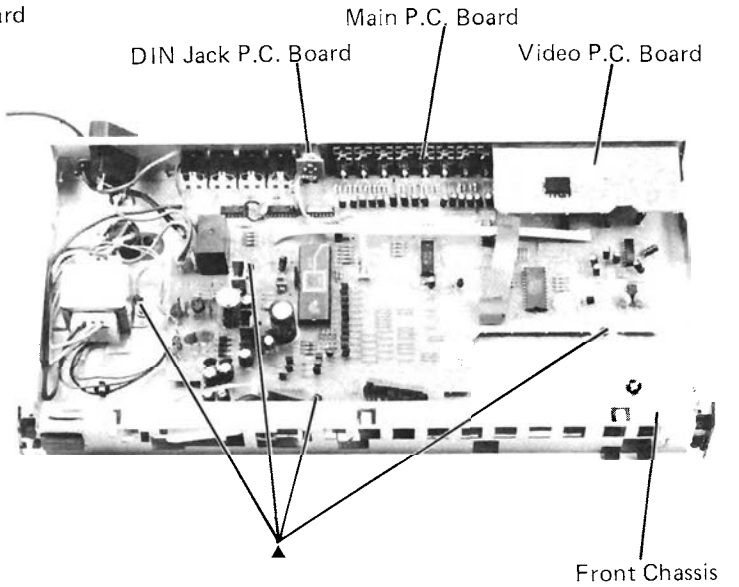

Figure 9

7. Removal of Main P.C. Board

- (1) Remove seven screws marked "☆" and four screws "▲" as shown in Figures 6 and 9.

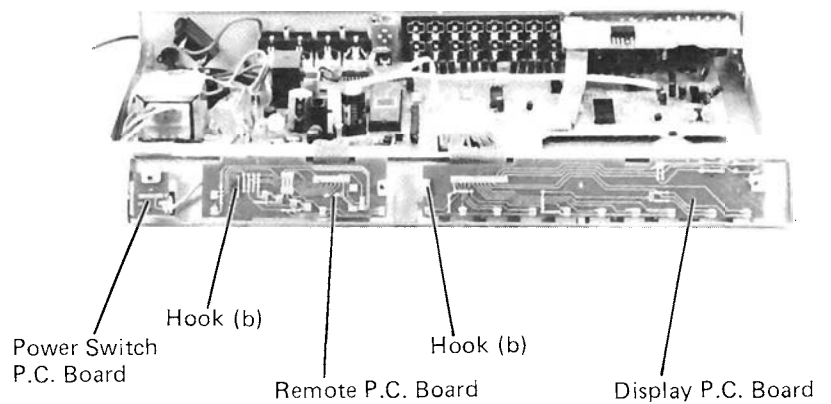
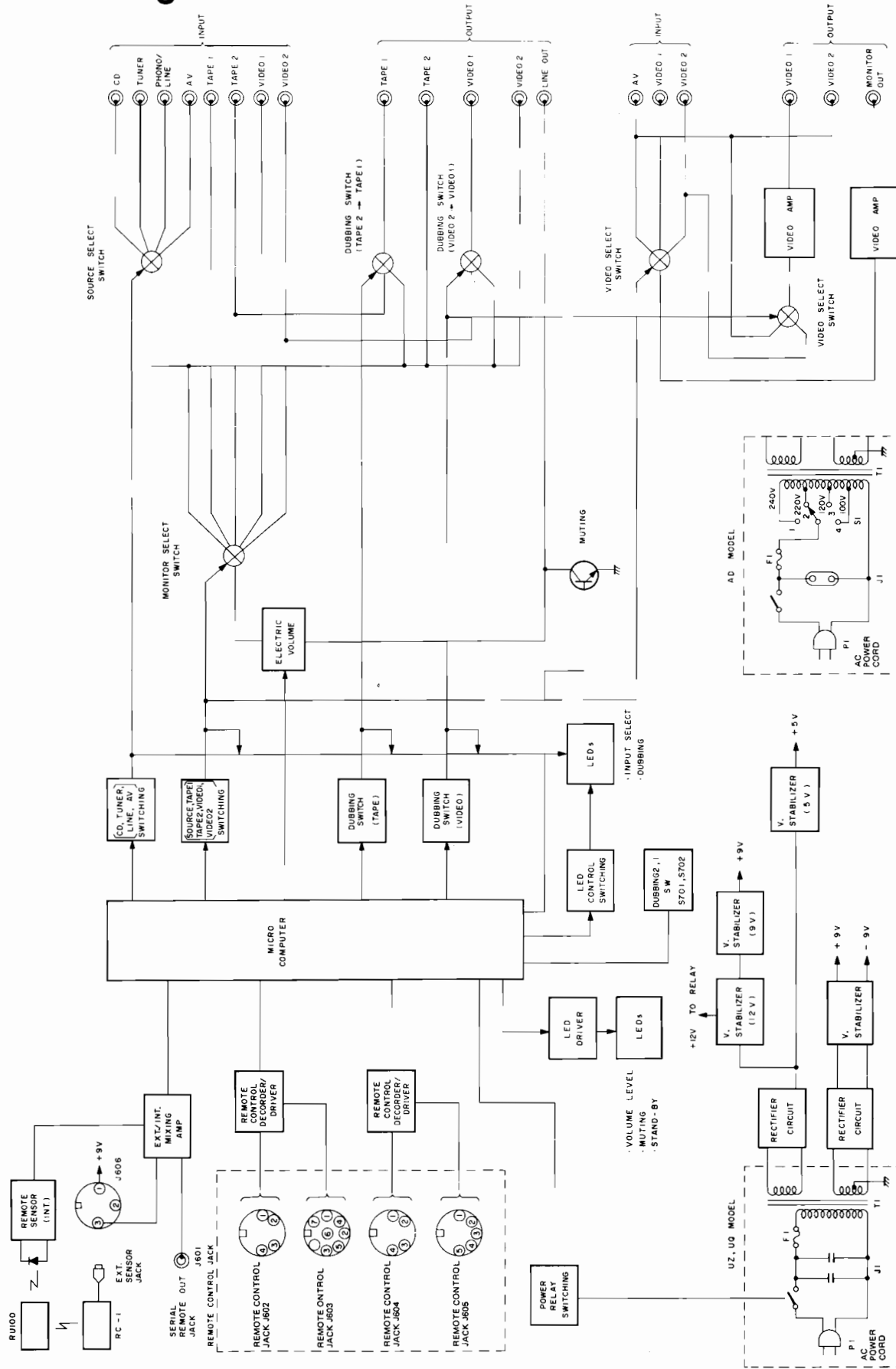

Figure 10

Block Diagram



Schematic Diagram

IC	IC501 IC502	IC301 IC302	IC402 IC401 IC304	IC601	IC604	IC901	IC1~IC5	IC603 IC602
Transistor (Q)		Q501~Q508	Q401 Q402	Q605~Q614 Q624 Q615 Q617 Q625	Q618~Q620	Q1	Q8 Q7	D606 D607 D1~D5
Diode (D,LD)				D610 D609 D608	LD701~LD710	LD801~LD807	D9 D6	

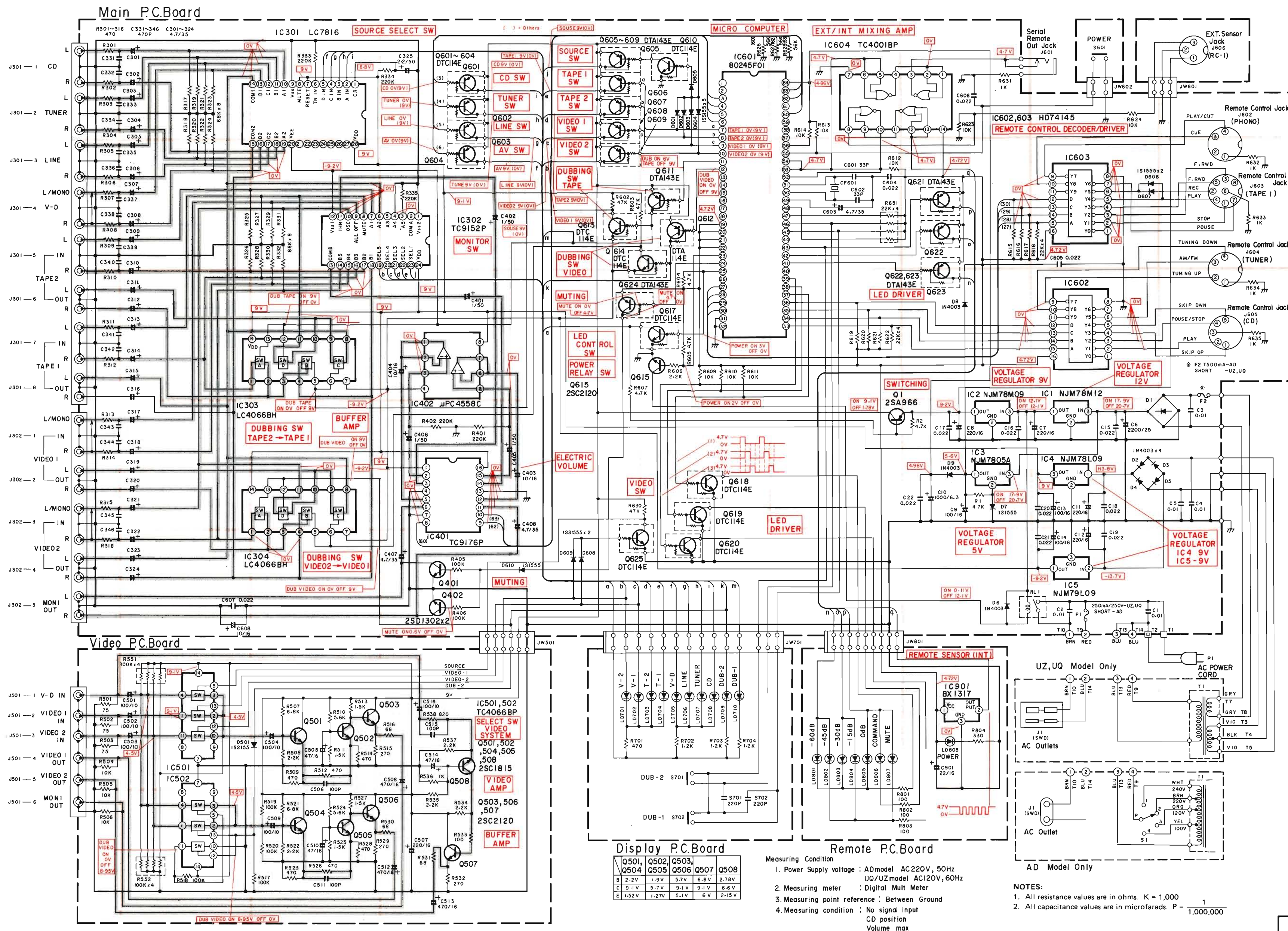

Parts Layout on P.C. Boards and Wiring Diagram

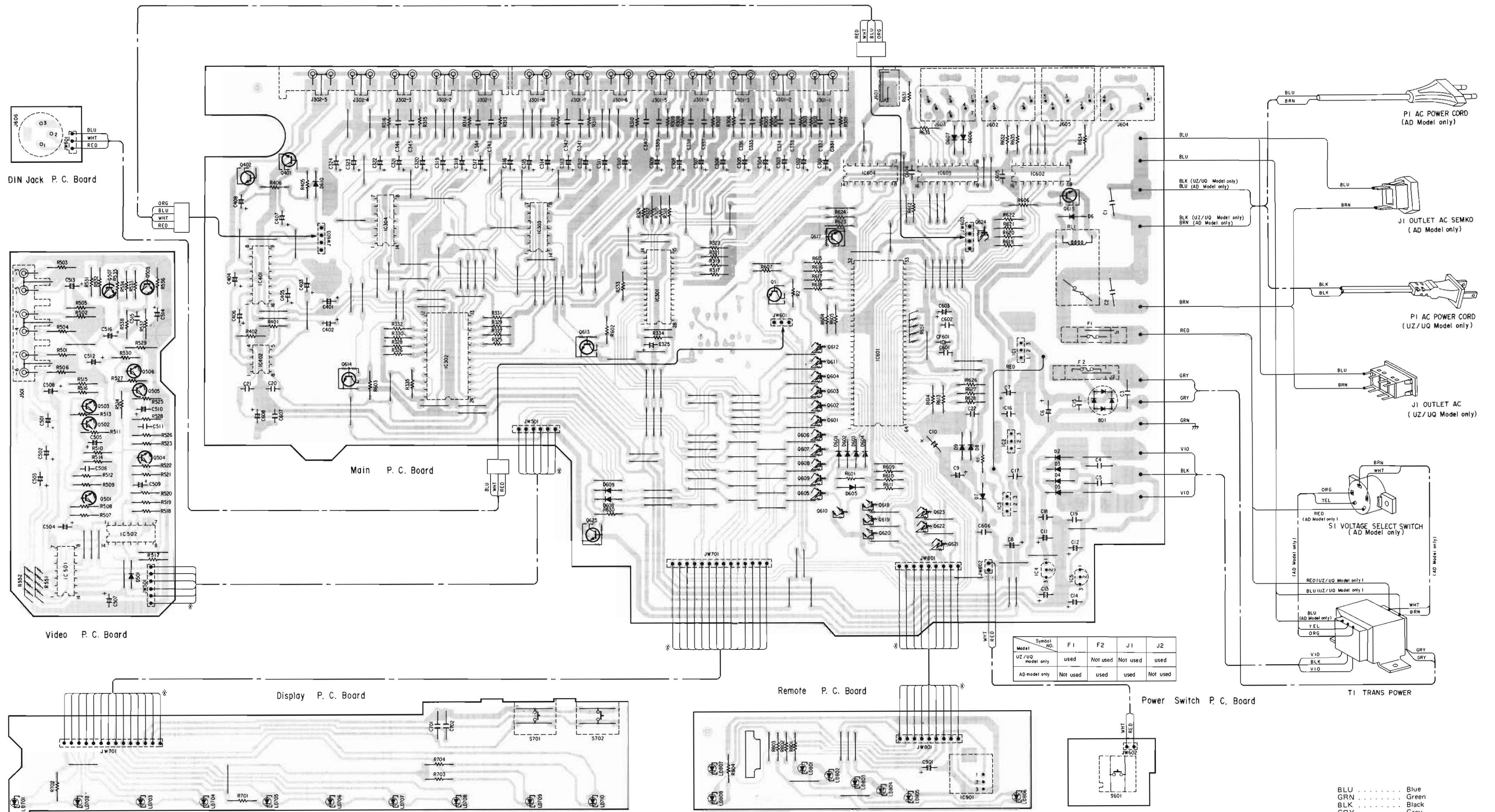

Model	Symbol No.	F1	F2	J1	J2
UZ/UQ model only		used	Not used	Not used	used
AD model only		Not used	used	used	Not used

- BLU Blue
- GRN Green
- BLK Black
- GRY Gray
- WHT White
- RED Red
- BRN Brown
- ORG Orange
- YEL Yellow
- VIO Violet
- PNK Pink
- GRN/WHT Green/White
- GRY/WHT Gray/White
- GRY/YEL Gray/Yellow
- GRN/YEL Green/Yellow
- SHLD Shield

Electrical Parts List

Resistors: Carbon resistors under ¼ watts are not mentioned in the parts list, please confirm them by schematic diagram.
uF = microfarads, pF = picofarads

Symbol No.	Part No.	Description
Main P.C. Board		
IC's		
IC1	51T72375F01	NJM78M12A
IC2	51T80250F01	NJM78M09
IC3	51T61180F04	NJM7805A
IC4	51T80251F01	NJM78L09
IC5	51T80252F01	NJM79L09
IC301	51T70967F01	LC7816
IC302	51T80246F01	TC9152P
IC303	51T70968F01	LC4066BH
IC304	51T70968F01	LC4066BH
IC401	51T80247F01	TC9176P
IC402	51S43471U02	μPC4558C
IC601	51T80245F01	80245F01
IC602	51T81716F01	HD74145
IC603	51T81716F01	HD74145
IC604	51T56272F01	TC4001BP
Transistors		
Q1	48T70969F01	2SA966
Q401	48T57305F01	2SD1302
Q402	48T57305F01	2SD1302
Q601	48T81715F07	DTA143E
Q602	48T81715F07	DTA143E
Q603	48T81715F07	DTA143E
Q604	48T81715F07	DTA143E
Q605	48T81715F07	DTA143E
Q606	48T81715F07	DTA143E
Q607	48T81715F07	DTA143E
Q608	48T81715F07	DTA143E
Q609	48T81715F07	DTA143E
Q610	48T81715F16	DTC114E
Q611	48T81715F07	DTA143E
Q612	48T81715F07	DTA143E
Q613	48T81715F16	DTC114E
Q614	48T81715F16	DTC114E
Q615	48T43015U01	2SC2120
Q617	48T81715F16	DTC114E
Q618	48T81715F16	DTC114E

Symbol No.	Part No.	Description
Q619	48T81715F16	DTC114E
Q620	48T81715F16	DTC114E
Q621	48T81715F07	DTA143E
Q622	48T81715F07	DTA143E
Q623	48T81715F07	DTA143E
Q624	48T81715F07	DTA143E
Q625	48T81715F16	DTC114E
Diodes		
BD1	48T50629F01	Bridge WL-02
D2	48S40477U01	IN4003
D3	48S40477U01	IN4003
D4	48S40477U01	IN4003
D5	48S40477U01	IN4003
D6	48S40477U01	IN4003
D7	48T43189F01	1S1555
D8	48S40477U01	IN4003
D9	48S40477U01	IN4003
D601	48T43189F01	1S1555
D602	48T43189F01	1S1555
D603	48T43189F01	1S1555
D604	48T43189F01	1S1555
D605	48T43189F01	1S1555
D606	48T43189F01	1S1555
D607	48T43189F01	1S1555
D608	48T43189F01	1S1555
D609	48T43189F01	1S1555
D610	48T43189F01	1S1555
Relay		
RL1	80T55299F02	G4W1112P-SKV

Symbol No.	Part No.	Description
Jacks		
J301-1	09T80237F01	RCA16P Switch
J301-2	09T80237F01	RCA16P Switch
J301-3	09T80237F01	RCA16P Switch
J301-4	09T80237F01	RCA16P Switch
J301-5	09T80237F01	RCA16P Switch
J301-6	09T80237F01	RCA16P Switch
J301-7	09T80237F01	RCA16P Switch
J301-8	09T80237F01	RCA16P Switch
J302-1	09T80238F01	RCA10P Switch
J302-2	09T80238F01	RCA10P Switch
J302-3	09T80238F01	RCA10P Switch
J302-4	09T80238F01	RCA10P Switch
J302-5	09T80238F01	RCA10P Switch
J601	09T80239F01	Mini Phone
J602	09T80241F01	DIN 4P
J603	09T80243F01	DIN 8P
J604	09T80241F01	DIN 4P
J605	09T80242F01	DIN 5P
Filter		
CF601	91T80244F01	Ceramic CSA3.6 MHz
Capacitors		
C1	08T57437F09	Ceramic 0.01 uF
C2	08T57437F09	Ceramic 0.01 uF
C3	21T68834F01	Ceramic 0.01 uF
C4	21T68834F01	Ceramic 0.01 uF
C5	21T68834F01	Ceramic 0.01 uF
C6	23T68328F33	Electrolytic 2200 uF/25V
C7	23S40657F52	Electrolytic 220 uF/16V
C8	23S40657F52	Electrolytic 220 uF/16V
C9	23S40657F14	Electrolytic 100 uF/16V
C10	23T68328F94	Electrolytic 0.01 uF/6.3V
C11	23S40657F52	Electrolytic 220 uF/16V
C12	23S40657F52	Electrolytic 220 uF/16V
C13	23S40657F14	Electrolytic 100 uF/16V
C14	23S40657F14	Electrolytic 100 uF/16V
C15	08S40805F21	Ceramic 0.022 uF

Symbol No.	Part No.	Description
C16	08S40805F21	Ceramic 0.022 uF
C17	08S40805F21	Ceramic 0.022 uF
C18	08S40805F21	Ceramic 0.022 uF
C19	08S40805F21	Ceramic 0.022 uF
C20	08S40805F21	Ceramic 0.022 uF
C21	08S40805F21	Ceramic 0.022 uF
C22	08S40805F21	Ceramic 0.022 uF
C301	23S40657F22	Electrolytic 4.7 uF/35V
C302	23S40657F22	Electrolytic 4.7 uF/35V
C303	23S40657F22	Electrolytic 4.7 uF/35V
C304	23S40657F22	Electrolytic 4.7 uF/35V
C305	23S40657F22	Electrolytic 4.7 uF/35V
C306	23S40657F22	Electrolytic 4.7 uF/35V
C307	23S40657F22	Electrolytic 4.7 uF/35V
C308	23S40657F22	Electrolytic 4.7 uF/35V
C309	23S40657F22	Electrolytic 4.7 uF/35V
C310	23S40657F22	Electrolytic 4.7 uF/35V
C311	23S40657F22	Electrolytic 4.7 uF/35V
C312	23S40657F22	Electrolytic 4.7 uF/35V
C313	23S40657F22	Electrolytic 4.7 uF/35V
C314	23S40657F22	Electrolytic 4.7 uF/35V
C315	23S40657F22	Electrolytic 4.7 uF/35V
C316	23S40657F22	Electrolytic 4.7 uF/35V
C317	23S40657F22	Electrolytic 4.7 uF/35V
C318	23S40657F22	Electrolytic 4.7 uF/35V
C319	23S40657F22	Electrolytic 4.7 uF/35V
C320	23S40657F22	Electrolytic 4.7 uF/35V
C321	23S40657F22	Electrolytic 4.7 uF/35V
C322	23S40657F22	Electrolytic 4.7 uF/35V
C323	23S40657F22	Electrolytic 4.7 uF/35V
C324	23S40657F22	Electrolytic 4.7 uF/35V
C325	23S40657F29	Electrolytic 2.2 uF/50V
C331	08T55260F45	Ceramic 470 pF
C332	08T55260F45	Ceramic 470 pF
C333	08T55260F45	Ceramic 470 pF
C334	08T55260F45	Ceramic 470 pF
C335	08T55260F45	Ceramic 470 pF
C336	08T55260F45	Ceramic 470 pF
C337	08T55260F45	Ceramic 470 pF
C338	08T55260F45	Ceramic 470 pF
C339	08T55260F45	Ceramic 470 pF
C340	08T55260F45	Ceramic 470 pF
C341	08T55260F45	Ceramic 470 pF
C342	08T55260F45	Ceramic 470 pF
C343	08T55260F45	Ceramic 470 pF

Symbol No.	Part No.	Description	
C344	08T55260F45	Ceramic	470 pF
C345	08T55260F45	Ceramic	470 pF
C346	08T55260F45	Ceramic	470 pF
C401	23S40657F28	Electrolytic	1 uF/50V
C402	23S40657F28	Electrolytic	1 uF/50V
C403	23S40657F10	Electrolytic	10 uF/16V
C404	23S40657F10	Electrolytic	10 uF/16V
C405	23S40657F28	Electrolytic	1 uF/50V
C406	23S40657F28	Electrolytic	1 uF/50V
C407	23S40657F22	Electrolytic	4.7 uF/35V
C408	23S40657F22	Electrolytic	4.7 uF/35V
C601	08T61939F23	Ceramic	33 pF
C602	08T61939F23	Ceramic	33 pF
C603	23S40657F22	Electrolytic	4.7 uF/35V
C604	08S40805F21	Ceramic	0.022 uF
C605	08S40805F21	Ceramic	0.022 uF
C606	08S40805F21	Ceramic	0.022 uF
C607	08S40805F21	Ceramic	0.022 uF
C608	23S40657F10	Electrolytic	10 uF/16V
Resistor			
R651	51T51133F07	Block	22K ohm x 4
Video P.C. Board			
IC's			
IC501	51T47739F01	TC4066BP	
IC502	51T47739F01	TC4066BP	
Transistors			
Q501	48T81101F01	2SC1815	
Q502	48T81101F01	2SC1815	
Q503	48T43015U01	2SC2120	
Q504	48T81101F01	2SC1815	
Q505	48T81101F01	2SC1815	

Symbol No.	Part No.	Description	
Q506	48T43015U01	2SC2120	
Q507	48T43015U01	2SC2120	
Q508	48T81101F01	2SC1815	
Diode			
D501	48T43189F01	1S1555	
Jacks			
J501-1	09T80256F01	RCA6P (YLR)	
J501-2	09T80256F01	RCA6P (YLR)	
J501-3	09T80256F01	RCA6P (YLR)	
J501-4	09T80256F01	RCA6P (YLR)	
J501-5	09T80256F01	RCA6P (YLR)	
J501-6	09T80256F01	RCA6P (YLR)	
Capacitors			
C501	23S40657F08	Electrolytic	100 uF/10V
C502	23S40657F08	Electrolytic	100 uF/10V
C503	23S40657F08	Electrolytic	100 uF/10V
C504	23S40657F08	Electrolytic	100 uF/10V
C505	23S40657F13	Electrolytic	47 uF/16V
C506	21S40655F23	Ceramic	100 pF
C507	23S40657F52	Electrolytic	220 uF/16V
C508	23T68328F19	Electrolytic	470 uF/16V
C509	23S40657F08	Electrolytic	100 uF/16V
C510	23S40657F13	Electrolytic	47 uF/16V
C511	21S40655F23	Ceramic	100 pF
C512	23T68328F19	Electrolytic	470 uF/16V
C513	23T68328F19	Electrolytic	470 uF/16V
C514	23S40657F13	Electrolytic	47 uF/16V
C515	21S40655F23	Ceramic	100 pF
C516	23S40657F08	Electrolytic	100 uF/10V

Symbol No.	Part No.	Description
Resistors		
R551	51T51133F02	Block 100K ohm x 4
R552	51T51133F02	Block 100K ohm x 4
Display P.C. Board		
LED's		
LD701	48T66959F01	SLR 54VC3F (RED)
LD702	48T66959F01	SLR 54VC3F (RED)
LD703	48T66959F01	SLR 54VC3F (RED)
LD704	48T66959F01	SLR 54VC3F (RED)
LD705	48T68847F01	SLR54MC3 (GRN)
LD706	48T68847F01	SLR54MC3 (GRN)
LD707	48T68847F01	SLR54MC3 (GRN)
LD708	48T68847F01	SLR54MC3 (GRN)
LD709	48T66959F01	SLR54VC3F (RED)
LD710	48T66959F01	SLR54VC3F (RED)
Switches		
S701	40T52952F01	KHC10903 (DUB-2)
S702	40T52952F01	KHC10903 (DUB-1)
Capacitors		
C701	08T55260F41	Ceramic 220 pF
C702	08T55260F41	Ceramic 220 pF
Remote P.C. Board		
IC		
IC901	51T80330F01	BX1317

Symbol No.	Part No.	Description
LED's		
LD801	48T66959F01	SLR54VC3F (RED)
LD802	48T66959F01	SLR54VC3F (RED)
LD803	48T66959F01	SLR54VC3F (RED)
LD804	48T66959F01	SLR54VC3F (RED)
LD805	48T66959F01	SLR54VC3F (RED)
LD806	48T66959F01	SLR54VC3F (RED)
LD807	48T66959F01	SLR54VC3F (RED)
LD808	48T66959F01	SLR54VC3F (RED)
Capacitor		
C901	23S57007F11	Electrolytic 22 uF/16V
Miscellaneous		
■ F1	65T66926F02	Fuse 51NM 250mA-250V
▲ F1	65T66926F02	Fuse 51NM 250mA-250V
● F2	65T42077U13	Fuse, Semko T-500mA
● J1	09T81260F01	Outlet, AC. Semko
■ J1	09T66965F02	Outlet, AC. P-2
▲ J1	09T66965F02	Outlet, AC. P-2
J606	09T80240F01	Jack, Din 3P
● P1	28T43812P04	AC Power Cord
■ P1	28T70972F01	AC Power Cord (SPT-2)
▲ P1	28T70972F01	AC Power Cord (SPT-2)
● S1	40T80258F01	Switch, Volt Select 4C
S601	40T52952F01	Switch, KHC10903 (Power)
● T1	25T80257F01	Trans, Power
■ T1	25T80258F01	Trans, Power
▲ T1	25T80259F01	Trans, Power

Note: ● : For West Germany model only (AD), ▲ : For Canadian model only (UQ),
 ■ : For North American model only (UZ), Others : Common

Parts List by the Destination

Symbol No.	Description	POWER SOURCE		
		UQ ▲ 120V	UZ ■ 120V	AD ● 220V
		Canada	North America	West Germany
F1	Fuse	65T66926F02	65T66926F02	Not Used
F2	Fuse	Not Used	Not Used	65T42077U13
J1	Outlet, AC	09T66965F02	09T66965F02	09T81260F01
P1	AC Power Cord	28T70972F01	28T70972F01	28T43812P04
S1	Switch, Volt Select	Not Used	Not Used	40T80258F01
T1	Trans, Power	25T81259F01	25T81258F01	25T80257F01
13	Cover, Rear	15D80269F02	15D80269F02	15D80269F01
31	Label, Fuse	54B62266F43	54B62266F43	Not Used
104-1	Owner's Manual	68P80130F55	68P81707F27	68P80130F55

Cabinet Assembly Parts List

Symbol No.	Index	Part No.	Description	Symbol No.	Part No.	Description
1	5-B	01V81100F81	Assembly, Front Panel			
2	4-A	07B73435F01	Frame, Panel Side (L)			
● 3		03S71031F04	Screw, Bind (M3 x 8)			
4	6-C	07B73435F02	Frame, Panel Side (R)			
5	2-D	15D74407F03	Cover, Top			
6	2-E	07A80267F01	Bracket, Jack			
10	3-C	03S40036U12	Screw, W/Washer (M4 x 6)			
11	5-B	75A80264F01	Cushion, Rubber			
12	5-B	15A81726F01	Cover, IC			
● 13		15D80269F01	Cover, Rear			
■ 13		15D80269F02	Cover, Rear			
▲ 13		15D80269F02	Cover, Rear			
14		43B41625J02	Support, Cord			
16	2-D	09T51410F01	Holder, Fuse (Semko)			
18	2-C	03D40014G04	Screw, W/Washer (M3 x 6)			
19	3-E	29A41814G01	Lug			
24	5-C	36B72195F02	Knob, Push			
25	4-B	36B81593F01	Knob, Power			
26		14S53017F73	Insulator, Cover			
29	5-D	75A60070F01	Pad, Rubber			
30	3-E	75S72374F11	Cushion, Rubber			
■ 31	2-D	54B62266F43	Label, Fuse			
▲ 31	2-D	54B62266F43	Label, Fuse			

Note: ● : For West Germany model only (AD), ▲ : For Canadian model only (UQ),
 ■ : For North American model only (UZ), Others : Common

NOTE: The parts without part number are not supplied.

Packing Assembly Parts List

Symbol No.	Part No.	Description	Symbol No.	Part No.	Description
101	56S71001F67	Carton, Packing	104-7	01T82091F01	Assembly, Mini Plug Cord
102	56B40230G34	Sack, Polyethylene	105	60T58064F01	Battery, SUM-3 "FUJI"
103	56D72204F02	Tray, Packing			
▲ 104-1	68P80130F55	Owners, Manual			
● 104-1	68P80130F55	Owners, Manual			
■ 104-1	68P81707F27	Owners, Manual			
104-2	01T80260F01	Remocon, RU-100			
104-3	01T81045F01	Assembly, DIN 4P			
104-4	01T81046F01	Assembly, DIN 5P			
104-5	01T81047F01	Assembly, DIN 8P			
104-6	28T51067F01	Plug, Short Phono			

Note: ● : For West Germany model only (AD), ▲ : For Canadian model only (UQ),
 ■ : For North American model only (UZ), Others : Common

Packing Method View

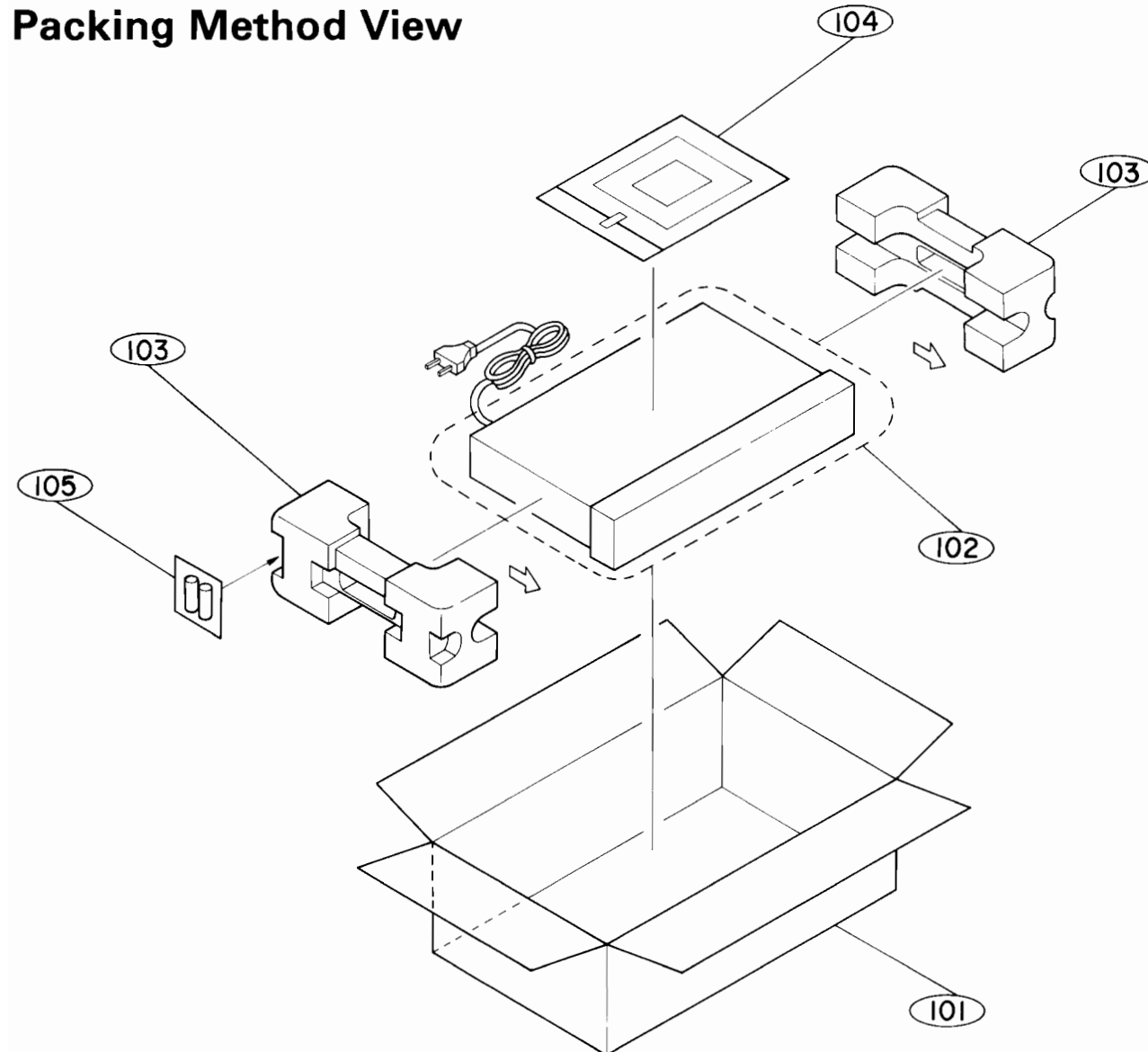

Semi-Conductor Lead Identifications

NJM78M12: IC1
NJM78M09: IC2
NJM7805A: IC3

1: OUTPUT
2: COMMON
3: INPUT

NJM79L09: IC4

1. GND
2. INPUT
3. OUTPUT

NJM78L09: IC5

INPUT 3 OUTPUT 1
GND 2

LC7816: IC301

TC9152P: IC302

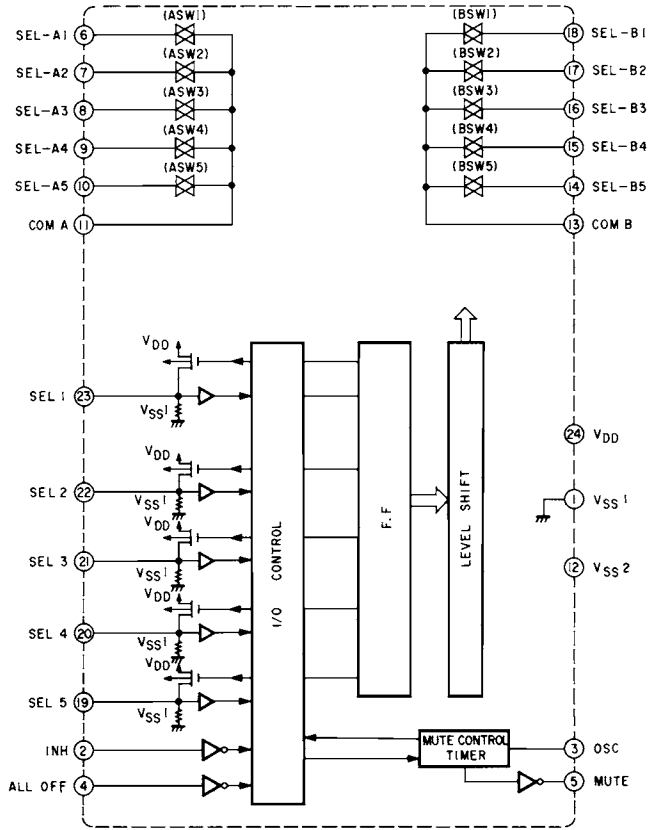
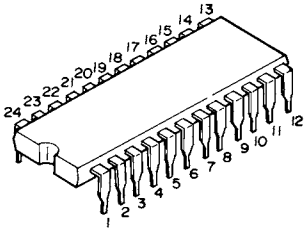

LC4066BH: IC303, 304

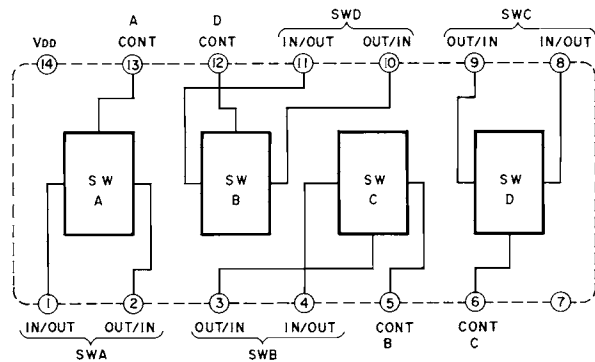
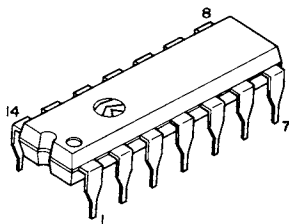

TC9176P: IC401

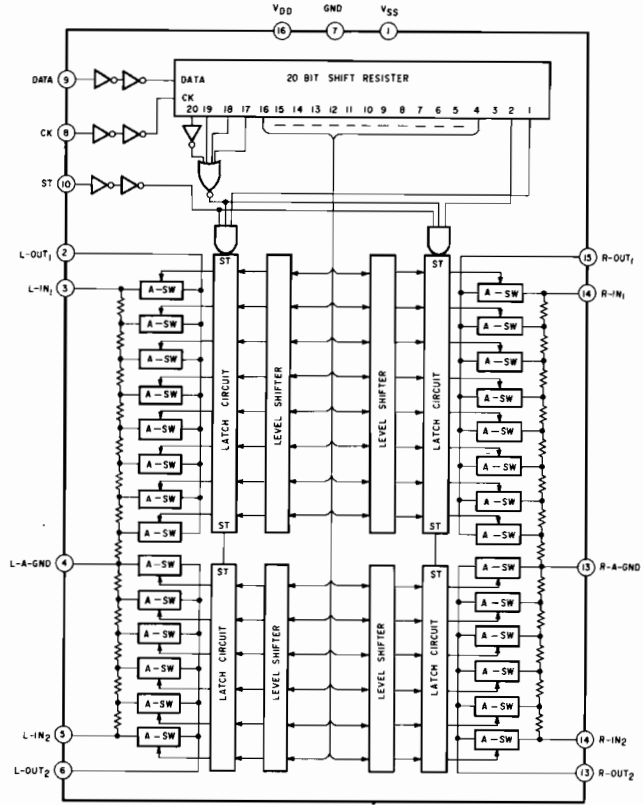
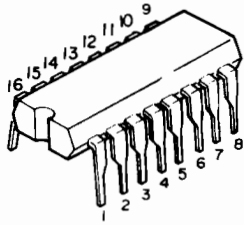

μPC4558C: IC402

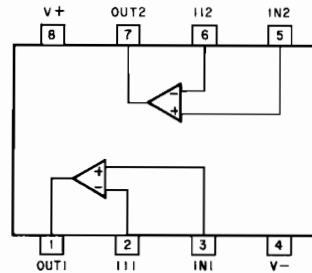
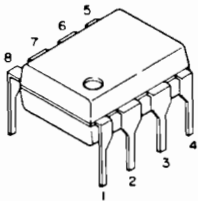

TC4066BP: IC501, 502

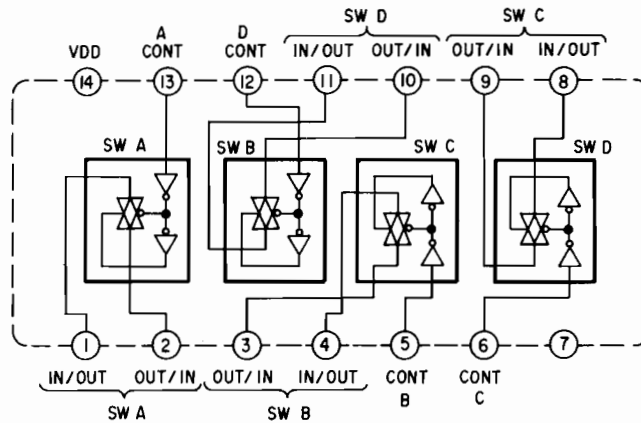
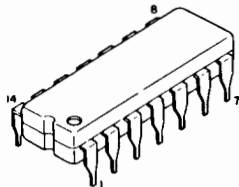

80245F01: IC601

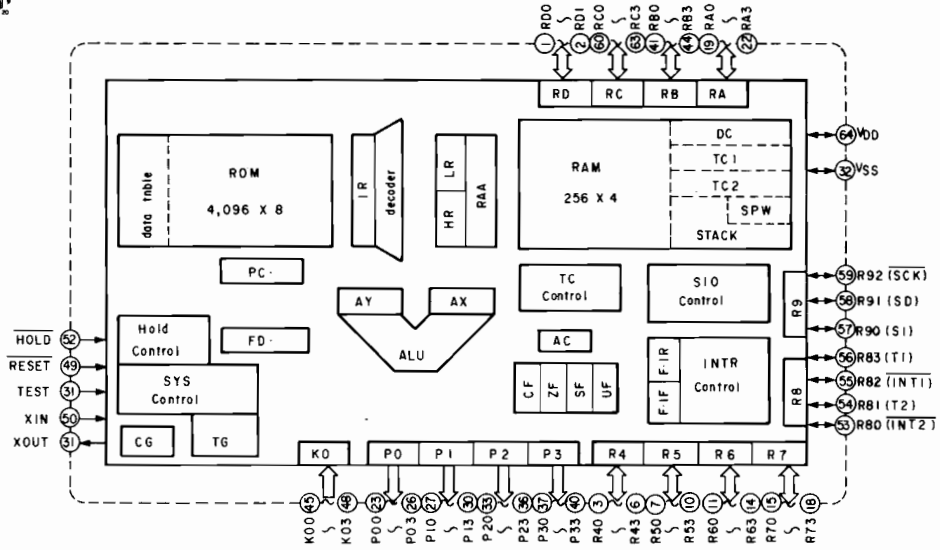
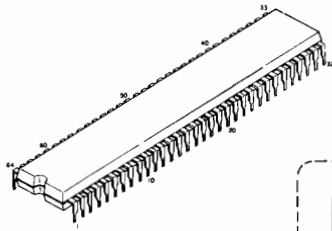

HD74145: IC602, 603

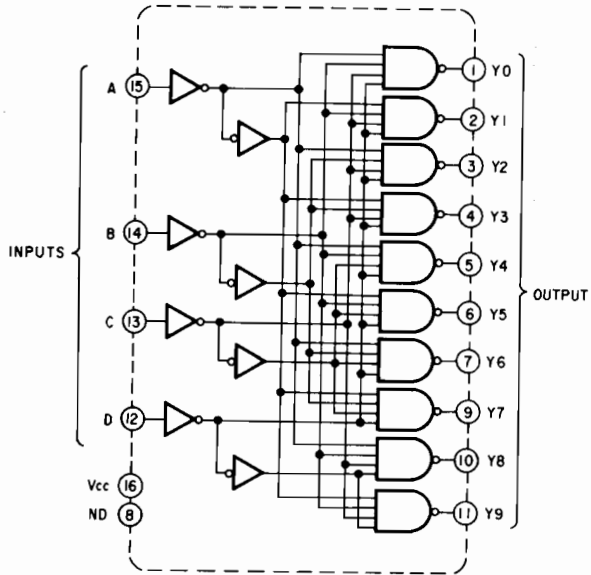
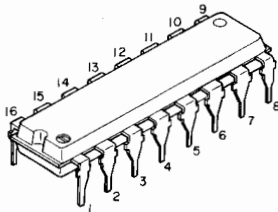

TC4001BP: IC604

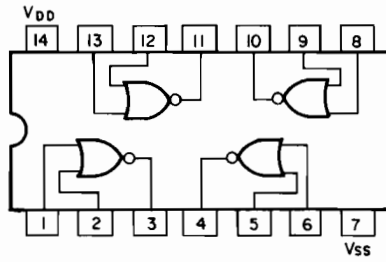
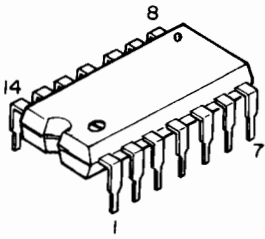

BX1317: IC901

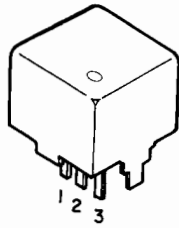

- 1. VCC
- 2. OUTPUT
- 3. GND

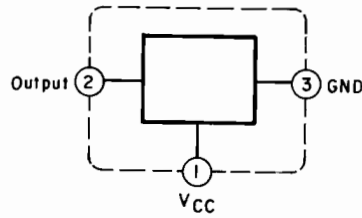

2SA966: Q1

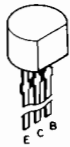

- 2SD1302: Q401, 402**
- 2SC1815: Q501, 502, 504, 505, 508**
- 2SC2120: Q503, 506, 507, 615**



DTA143E: Q601 ~ 609, 611, 612, 621 ~ 624

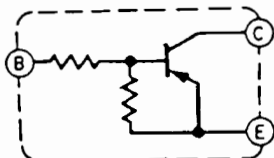

DTC114E: Q610, 613, 614, 617 ~ 620, 625

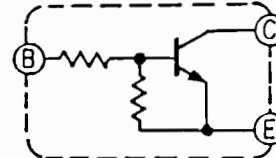



LUX CORPORATION, JAPAN

1-1-8 Nishi Gotanda, Shinagawa-ku, Tokyo, 141 JAPAN
Phone: 03-494-1101 Telex: 8927-61