

LUXMAN

T-353

Digital Synthesized AM/FM Stereo Tuner

OWNER'S MANUAL
BEDIENUNGSANLEITUNG
MODE D'EMPLOI
MANUAL DE OPERACIÓN
LIBRETTO DELLE ISTRUZIONI

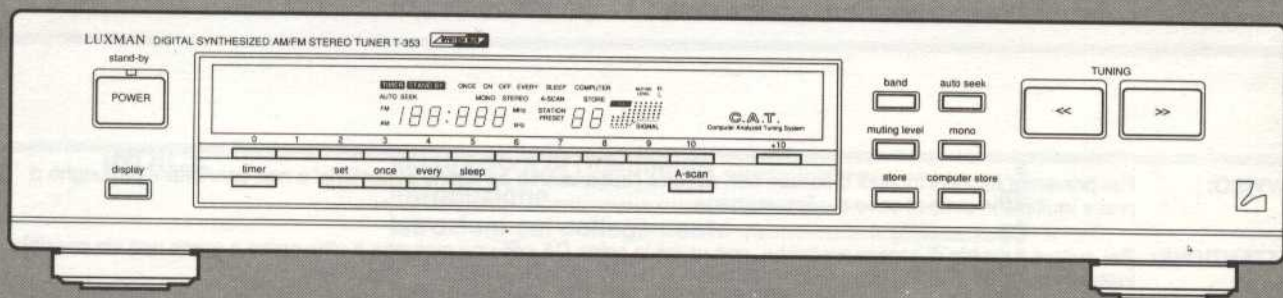

Names & Functions of Parts

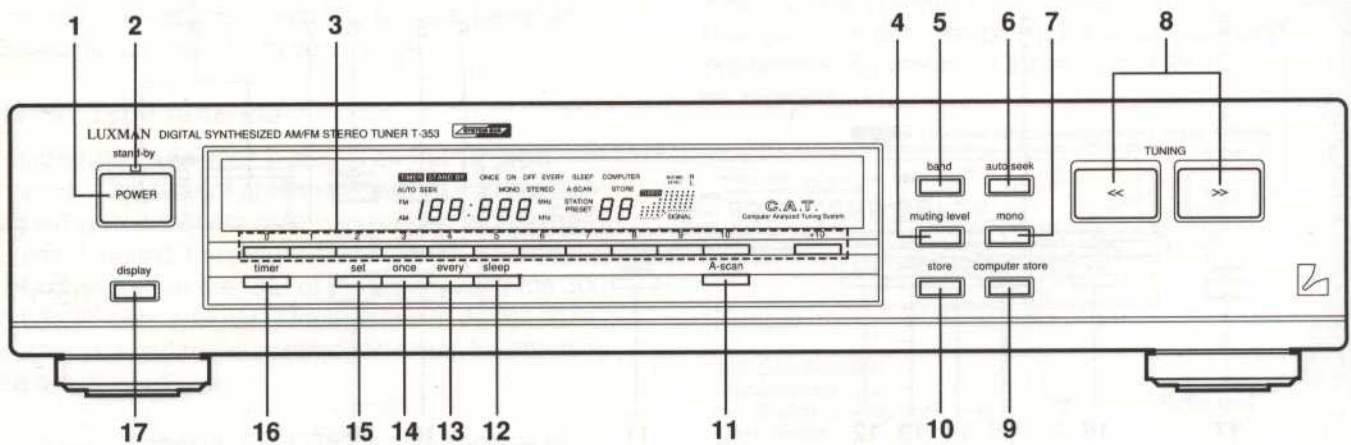

8. "TUNING <</>>" buttons

Allow manual up/down tuning and initiate auto tuning in the "auto seek" mode (see item #6).

9. "computer store" button

For automatic "computer store" of a series of FM or AM (LW/MW) stations, press this button for more than 1 second. When the "COMPUTER STORE" indicators (items #27 and #26) come on, press the preset number at which you want the storing operation to start. Stations will be sequentially stored in an upward direction into the presets beginning with the first AM (LW/MW) or FM station tuned. For more details, refer to page 13.

10. "store" button

Pressing this button will allow any tuned AM (LW/MW) or FM station to be stored in any one of the 30 AM/FM RANDOM STATION PRESET locations (see also item #3). If you wish to store a station that you have tuned, momentarily press this button. When the "STORE" indicator (item #26) comes on, press the preset button into which you wish to store it.

11. "A-scan" (auto memory scan) button

Press this button to blink the preset radio band, frequency and preset-location number on the display. The "A-SCAN" indicator (item #24) lights up during the auto scan mode. Press again to cancel this mode.

12. "sleep" button

Press the "sleep" button for using the sleep timer (see page 15).

13. "every" button

Press the "every" button for using the everyday timer. (see page 15)

14. "once" button

Press the "once" button for using the once timer. (see page 17)

15. "set" button

Press the "set" button for setting the clock and timer.

16. "timer" button

Press the "timer" button for using the timer function.

17. "display" button

Press the "display" button to switch the display between the radio frequency and time. In the sleep timer mode, pressing this button changes the display in the order of the timer remaining time, clock time and radio frequency.

Names & Functions of Parts

Display

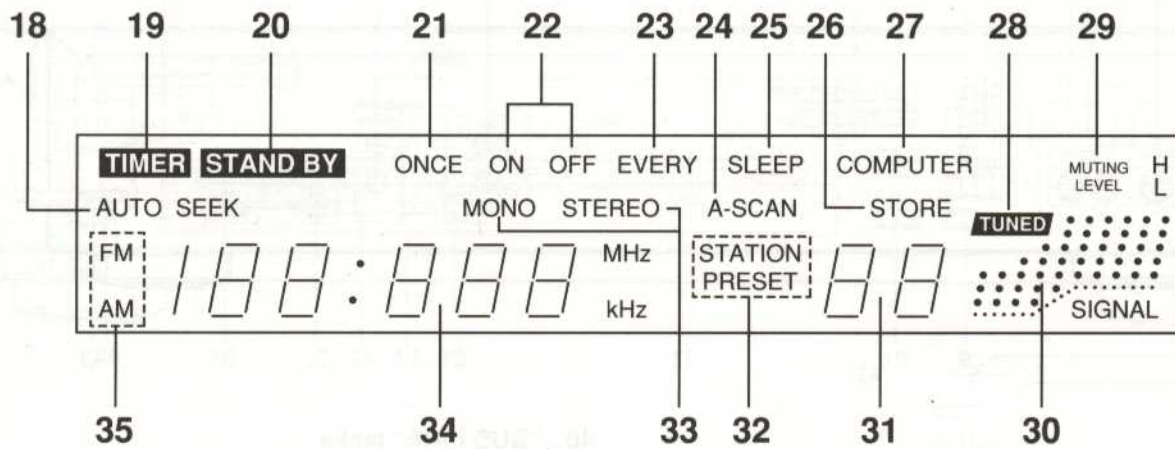

- | | |
|------------------------------|----------------------------------|
| 18. "AUTO SEEK" Indicator | 27. "COMPUTER" indicator |
| 19. "TIMER" indicator | 28. "TUNED" indicator |
| 20. "STAND BY" indicator | 29. "MUTING LEVEL H/L" indicator |
| 21. "ONCE" timer indicator | 30. "SIGNAL" Level indicators |
| 22. Timer "ON/OFF" indicator | 31. Station Preset No. indicator |
| 23. "EVERY" timer indicator | 32. "STATION PRESET" indicator |
| 24. "A-SCAN" indicator | 33. "MONO/STEREO" indicator |
| 25. "SLEEP" indicator | 34. Radio Frequency/Time display |
| 26. "STORE" indicator | 35. FM, AM Band indicators |

Names & Functions of Parts

Rear panel

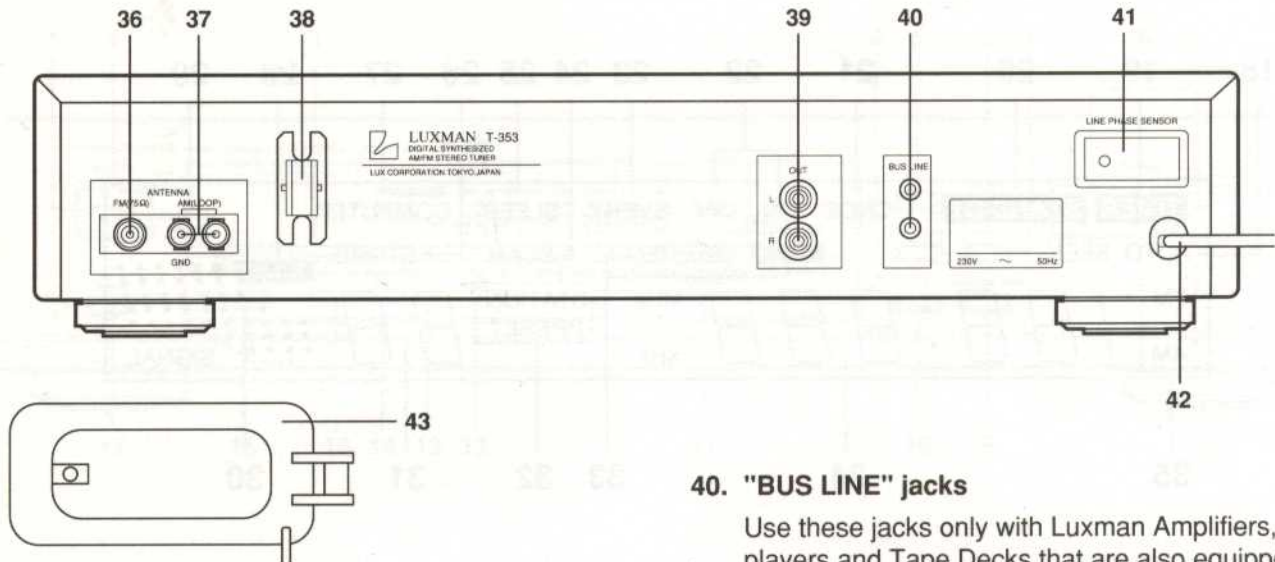

36. "FM (75 Ω)" terminal

For connection of 75 ohm coaxial cable lead-in with "DIN" connector, or a 300 ohm lead-in used with the 300-to-75 ohm adapter supplied. See diagram below.

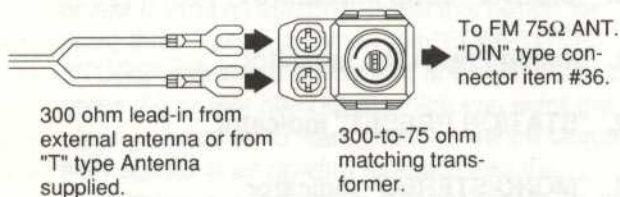

37. "AM (LOOP)" antenna terminals

For connection of the leads of the AM Loop Antenna (item #43) supplied with the T-353.

38. Holder-AM Antenna

This holder is designed for easy mounting or removal of the AM LOOP ANTENNA. Align mating surfaces carefully and install with a firm push.

39. "OUT L/R" (output left/right) jacks

Connect these jacks to the TUNER IN jacks on the rear of your amplifier.

40. "BUS LINE" jacks

Use these jacks only with Luxman Amplifiers, CD players and Tape Decks that are also equipped with BUS LINE jacks, such as the A-383, the D-373 and the K-373.

When interconnecting these units with the T-353, the mini phone cables may be inserted into either of their two BUS LINE jacks (the control signals are bidirectional, therefore no "IN/OUT" protocol is required).

41. "LINE PHASE SENSOR" and indicator

When plugging the AC power cord into the wall outlet, check the polarity of the AC power cord at this sensor and indicator. When the sensor is touched after connecting the AC power cord, the polarity is correct if the indicator remains unlit. If the indicator lights up, unplug the AC power cord then plug its other side into the AC wall outlet.

Note:

Check the polarity before connecting any other sources. If you live in an apartment building where the power supply is floating, the indicator may not change status.

42. AC Power Cord

Insert the AC plug of the T-353 into appropriate wall outlet.

43. AM Loop Antenna

This antenna can be rotated on its holder (item #38) for maximum pick-up, or removed and placed elsewhere for best reception (within the limitation of its 23" (58 cm) lead length).

Operation Guidelines

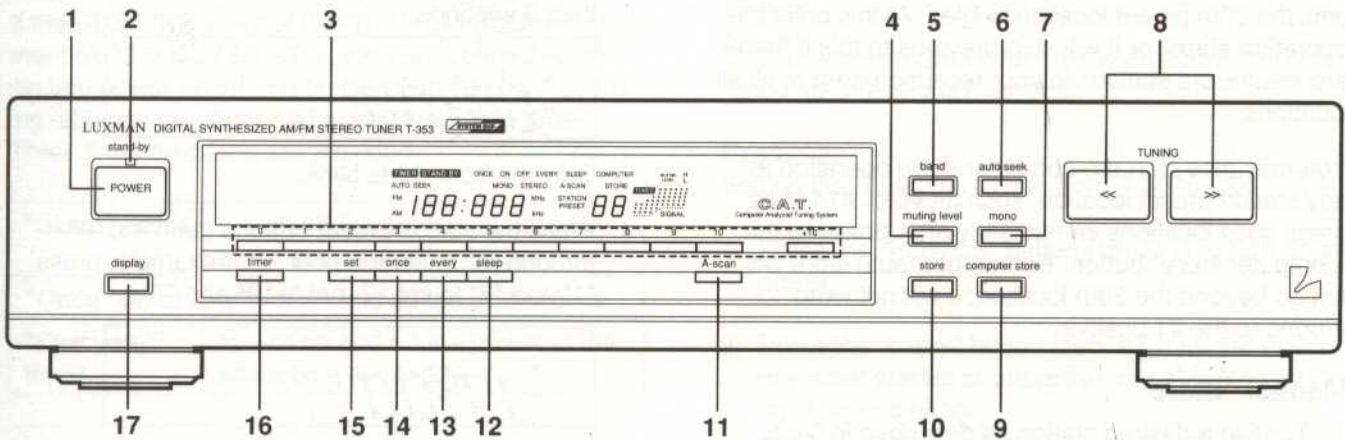

The following guidelines assume that all connections have been made according to the "Reference Illustrations," page 4.

Initial Set-up

Make sure all connections are securely made. Turn the volume of the amplifier fully down and turn the power on to all the components in use. Adjust the volume of the amplifier to a suitable level just prior to playback.

FM/AM (LW/MW) Tuning

The T-353 incorporates several tuning methods to provide ease, yet great flexibility in station selection and use. Proceed as follows:

Auto Tuning

1. Press the "band" select button (item #5) to indicate the desired band, "FM or AM" in the display.
2. Press the "auto seek" button (item #6) to indicate "AUTO SEEK" in the display.
3. Press the "TUNING <</>" buttons (item #8) to select the desired broadcast station.

- When a station is tuned in, "TUNED" is indicated.
- When a stereo program is tuned in, "TUNED" and "STEREO" are indicated.

- To tune in a station with weak signals, press the "auto seek" button to turn off the "AUTO SEEK" indicator. Then press "TUNING <</>" buttons (item #8).

Notes:

- To receive a stereo program, be sure to display the "STEREO" indicator (item #33) by pressing the "mono" button (item #7).
- If noise is heard while listening to FM or AM (LW/MW) broadcasts, it may be necessary to turn off the CD player, video disc player or TV.

Station Preset Operation

A total of 30 AM/FM stations can be stored in any order in preset numbers 1 to 30.

Auto "computer store"

If you wish to have the internal computer of the T-353 store a series of stations for you, proceed as follows:

1. Select AM (LW/MW) or FM as desired by pressing the "band" button (item #5).
2. Press the "TUNING <</>" buttons (item #8) to the frequency of the station from which you wish to have the computer store operation begin.
3. Press the "computer store" button (item #9). "COMPUTER" and "STORE" will appear in the display.
4. Press the station presets button (item #3) within 7 seconds.

Operation Guidelines

The tuner will now scan upward and store stations until the 30th preset location is filled. At this point the operation stops, or it will stop previous to this if there are insufficient stations in your reception area to fill all locations.

You may also start the computer store operation at any station preset location, such as #6 or #14. Just press such locations immediately after pressing the "computer store" button. Remember, auto store will not go beyond the 30th location; it will not wrap around to the #1 position.

Manual "Store"

1. Tune in a desired station as described in "Auto Tuning."
2. Press the "store" button (item #10). The "STORE" indicator will show for 7 seconds in the display.
3. Select and press a desired station preset number between 1 and 30 (item #3) while the "STORE" indicator is lit.

Station Recall

Press the station preset number of the desired station with the station preset buttons (item #3).

Setting the Clock

When you connect the AC power cord to a wall outlet, the time indication will blink until you set the clock. Follow the steps below to set the clock.

Example:

Setting to 17:45

1. Press the "POWER" button (item #1) to turn on the power.

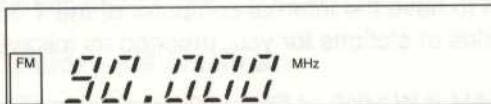

A radio frequency indication will appear in the display window.

2. Press the "display" button (item #2) so that the time is displayed.

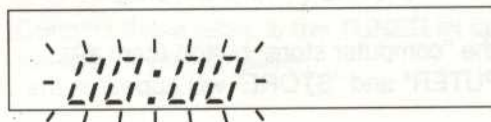

3. Press and hold the "set" button (item #15) for more than 3 seconds.

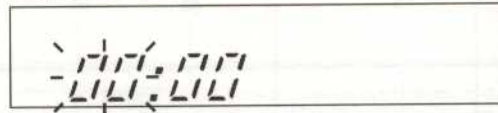

Only the hour digits blink.

4. Press the station preset buttons (item #3) "0" through "9" to set the hour. (For example, press "1" and "7" to set 17, not "+10" and "7".)



Note:

To input numerals for clock/timer settings, use the station preset location buttons from "0" to "9."

5. Press the "set" button.

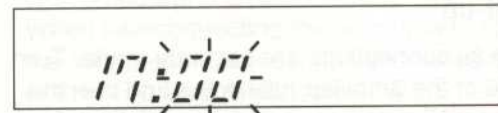

The hour is set and the minute digits blink.

6. Press the station preset buttons "4" and "5" to set the minutes.

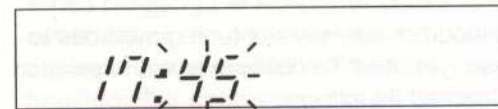

7. Press the "set" button when you hear the time signal on a radio, etc.

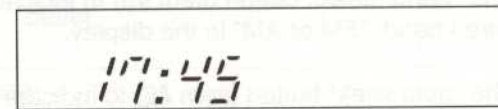

The present time is set. The clock begins counting at 00 seconds although it does not indicate seconds.

Notes:

- If a power interruption occurs after the time has been set, the time indication shows 00:00. In this case, reset the time.
- Before starting the timer setting procedure, make sure that the time setting is properly made.

Operation Guidelines

Using the Timer

If the BUS LINE jacks of the "SYSTEM BUS" equipment (A-383, K-373, D-373, etc.) are connected, the system power on/off and timer-activated play, recording, etc. can be performed using the built-in timer. Three timer functions are provided.

| | |
|------------------|---|
| "Sleep" timer | to turn off the power automatically at the preset time |
| "Once" timer | to turn on and off the power once |
| "Everyday" timer | to turn on and off the power at the same time every day |

Notes:

- Set the clock before setting the timer. Timer setting is not possible if the clock is not set.
- The TIMER and STANDBY indicators appear only when the T-353 is BUS connected.

Setting the Sleep Timer

The sleep timer will turn the Bus Line connected system off after a preset time has passed. The timer can be set for up to 90 minutes in 10 minute decrements.

- 1.) Press the "sleep" button (item #12) while receiving a station or while playing any source.

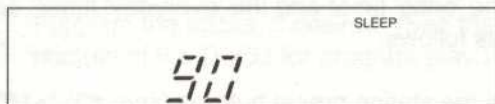

The system will turn off after about 90 minutes.

- 2.) To change the sleep time, press the "sleep" button repeatedly until the desired time is displayed. Each time the "sleep" button is pressed, the time indication changes as follows:

→ 90 → 80 → 70 → 60... → 10 → current time

During sleep timer operation, the display shows the remaining time in 1 minute decrements. The power will be turned off when 0 is reached.

- To cancel the sleep timer, press the "sleep" button repeatedly until the "SLEEP" indicator goes off.

Setting the Once Timer and Everyday Timer

The timer setting procedure is the same for both the "once" and "everyday" timers.

Example:

Setting the "everyday" timer from 7:30 to 8:00

1. Press the "POWER" button (item #1) to turn on the power.
2. Press the "every" button (item #13) for the everyday timer setting or press the "once" button for the once timer setting.

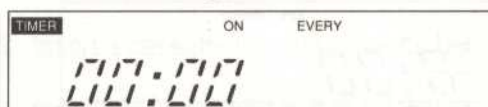

"ON " and "EVERY" or "ONCE" appear.

3. Press the "set" button (item #15).

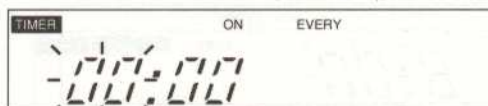

The "ON" hour digits blink.

4. Press the station preset button "7" (item #3) to set the "ON" hour.



Press until "7" blinks.

5. Press the "set" button.

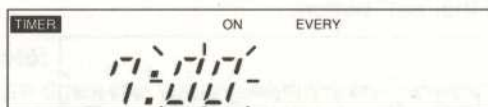

The hour is set and the minute digits blink.

6. Press the station preset buttons "3" and "0" to set the "ON" minutes.



Press until "30" blinks.

Operation Guidelines

7. Press the "set" button.

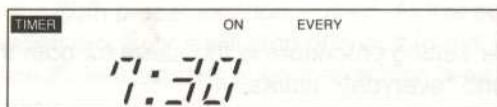

The "ON" minutes are set and the "OFF" hour digits blink.



8. Press the station preset button "8" to set the "OFF" hour.

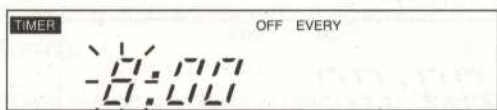

Press until "8" blinks.

9. Press the "set" button.

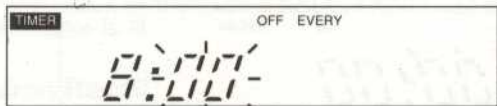

The hour is set and the minute digits blink.

10. Press the station preset buttons to set the "OFF" minutes.



(To set to "00" minutes as in this example, do not press the station preset buttons.)

11. Press the "set" button.



The "ON" and "OFF" times are set. "OFF" and "EVERY" or "ONCE" go off and the station preset number blinks for 7 seconds.

To receive a broadcast station with the timer, proceed to step 12 while the preset number is blinking. (See "Using the 'Everyday' Timer for Wake-up Alarm" on this page, or "Using the 'Once' Timer for Unattended Recording" on page 17.)

Setting the timer for sources other than the tuner is now complete. Prepare for playing the source, referring to page 17.

- To set the "once" timer, instead of step 2 above, press the "once" button (item #14) so that "ONCE" appears. The other procedures are the same as those for the "everyday" timer setting.

Notes:

- The "once" timer can be set within 24 hours from the present time.
- When using both the "once" and "everyday" timers, do not set the same "OFF" time of one timer and "ON" time of the other timer. Keep an interval of at least one minute between the operation times of the two timers.

Using the "Everyday" Timer for Wake-up Alarm

Example:

To be awakened by a broadcast of the station preset on the preset number 12 (FM 90.00 MHz) from 7:30 to 8:00 every day

Set the "everyday" timer following steps 1 to 11 of "Setting the 'once' timer and the 'everyday' timer" and proceed as follows:

12. Press the station preset buttons (item #3) "+10" and "2" in this order.

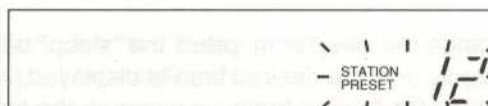

Preset number "12" blinks.

13. Press the "set" button (item #15).

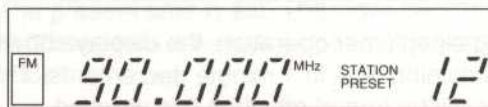

The station is now preset in the timer.

14. Press the "timer" button (item #16) on the tuner so that "EVERY" appears.

Operation Guidelines

15. Make sure that the indicator of the Input Select button "TUNER" lights on the amplifier.
16. Press the "POWER" button on the amplifier or tuner to turn off the whole system.



The system will be turned on and the preset station will be tuned in at 7:30. The system will be turned off at 8:00.

Note:

The time preset in the "everyday" timer is retained in the memory after the system is turned on and turned off.

Example:

To be awakened by CD play

Set the "everyday" timer following steps 1 to 13 of "Setting the 'once' Timer and the 'everyday' Timer" and then proceed as follows:

14. Insert a disc into the CD player.

Program the tracks, if desired. (See the Owner's Manual of the D-353 for program play.)
15. Press the "timer" button (item #13) on the tuner so that "EVERY" appears.
16. Press the Input Select button "CD" on the amplifier.
17. Press the "POWER" button on the amplifier or tuner to turn off the whole system.

CD play will begin at 7:30 and the system will be turned off at 8:00.

Using the "Once" Timer for Unattended Recording

Example:

To record a broadcast of the station preset on the preset number 12 (for example, FM 90.00 MHz) from 7:30 to 8:00.

Set the "once" timer following steps 1 to 13 of "Setting the 'once' timer and the 'everyday' timer" and proceed as follows:

14. Press the Input Select button "TUNER" on the amplifier.
15. Insert a cassette into the cassette deck.
16. Press the "timer rec" button on the cassette deck.
17. Press the "timer" button on the tuner so that "ONCE" appears.

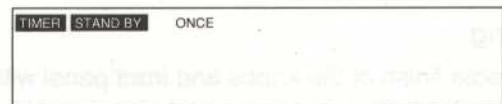

18. Make sure the indicator of the Input Select button "TUNER" lights on the amplifier.
If not, press "TUNER" to turn it on.
19. Press the "POWER" button on the amplifier or tuner to turn off the whole system.

The preset station will be tuned in and recording will begin at 7:30. The system will be turned off at 8:00.

Note:

Turn down the volume of the amplifier when conducting an unattended recording.

Operation Guidelines

- **To check the timer programs**

For the "everyday" timer, press the "every" button. For the "once" timer, press the "once" button. Each time the button is pressed, the "ON" time, the "OFF" time, and the station (only when preset in the timer) are displayed in sequence.

- **To change the preset time**

Press "every" or "once" to display the time to be changed. Press the "set" button. Change the time by pressing the station preset buttons, and press the "set" button again.

- **Priority of the timers**

- The sleep timer has priority, followed by the "once" timer and the "everyday" timer, in this order.
- If the "OFF" time of the timer with the higher priority and the "ON" time of the timer with the lower priority are the same, the latter one does not operate.

Remote Control

The T-353 comes without remote control unit. When the T-353 is connected into a BUS LINE system with other Luxman products, you can use the remote control unit supplied with other equipment in your system. To use that remote control unit, refer to the equipment's Owner's Manual.

Care and Maintenance

Cleaning

The durable finish of the knobs and front panel will last indefinitely with proper care and cleaning. Never use scouring pads, steel wool, scouring powders, or harsh chemical agents, such as lye solution. These will mar the finish. Clean with a soft, lint-free cloth or cotton swab slightly dampened with a mild solution of detergent and water.

Repacking for Shipment

Should it become necessary to ship your T-353 for any reason, use the original packing materials. If these are no longer available, be sure that adequate materials, at least equivalent to the original, are used.

Repairs

Only the most competent and qualified service technicians should be allowed to service the T-353. The Luxman company and its factory-trained warranty station personnel have the knowledge and special equipment needed for repair and calibration of this precision instrument. In the event of difficulty, call the Luxman Authorized Service Station nearest your home or business. In many cases, the dealer where you purchased your Luxman unit will be equipped to provide service.

Specifications

FM Tuner Section

| | |
|---|-------------------|
| Tuning Range | 87.5 to 108.0 MHz |
| Usable Sensitivity (98.0 MHz): | |
| Mono | 10.8 dBf |
| S/N at 65 dBf (98.0 MHz): | |
| Mono | 78 dB |
| Stereo | 65 dB |
| Distortion at 65 dBf (98.0 MHz): | |
| Mono, 1 kHz | 0.1% |
| Stereo, 1 kHz | 0.15% |
| Stereo Separation (1 kHz) | 48 dB |
| Alternate Channel Selectivity .. 75 kHz deviation | 62 dB |
| Capture Ratio at 65 dBf (98.0 MHz) | 1.5 dB |
| Image Response Ratio (at 106.1 MHz) | 90 dB |
| IF Response Ratio | 95 dB |
| Spurious Response Ratio | 100 dB |
| Frequency Response (30 Hz to 15 kHz) | ±0.5 dB |
| Muting Threshold Level | 26 dBf |
| Output Level | 800 mV |

AM (LW/MW) Tuner Section

| | |
|---|------------------|
| Tuning Range: | |
| LW | 153 to 281 kHz |
| MW | 522 to 1,611 kHz |
| Usable Sensitivity: | |
| LW | 68 dB/m |
| MW | 54 dB/m |
| S/N Ratio (100 mV/m): | |
| LW | 50 dB |
| MW | 54 dB |
| Distortion (LW, MW) | 0.3% |
| Image Response Ratio (MW 100 kHz) | 40 dB |
| Output Level (MW 30% mod. 400 Hz) | 200 mV |

General

| | |
|------------------------------|-------------------------|
| Power Supply | 120 V 60 Hz/230 V 50 Hz |
| Dimensions (W × H × D) | 438 × 90 × 355 mm |
| Weight: | |
| (Net) | 4.0 kg |
| (Gross) | 5.3 kg |

Design and specifications are subject to change without notice.

• Supplied Accessories

- FM "T" type antenna
- AM loop antenna
- 300 to 75 ohm adapter
- Audio phono-plug patch cord
- "SYSTEM BUS" cable

Fig. 1/Abb. 1/III. 1

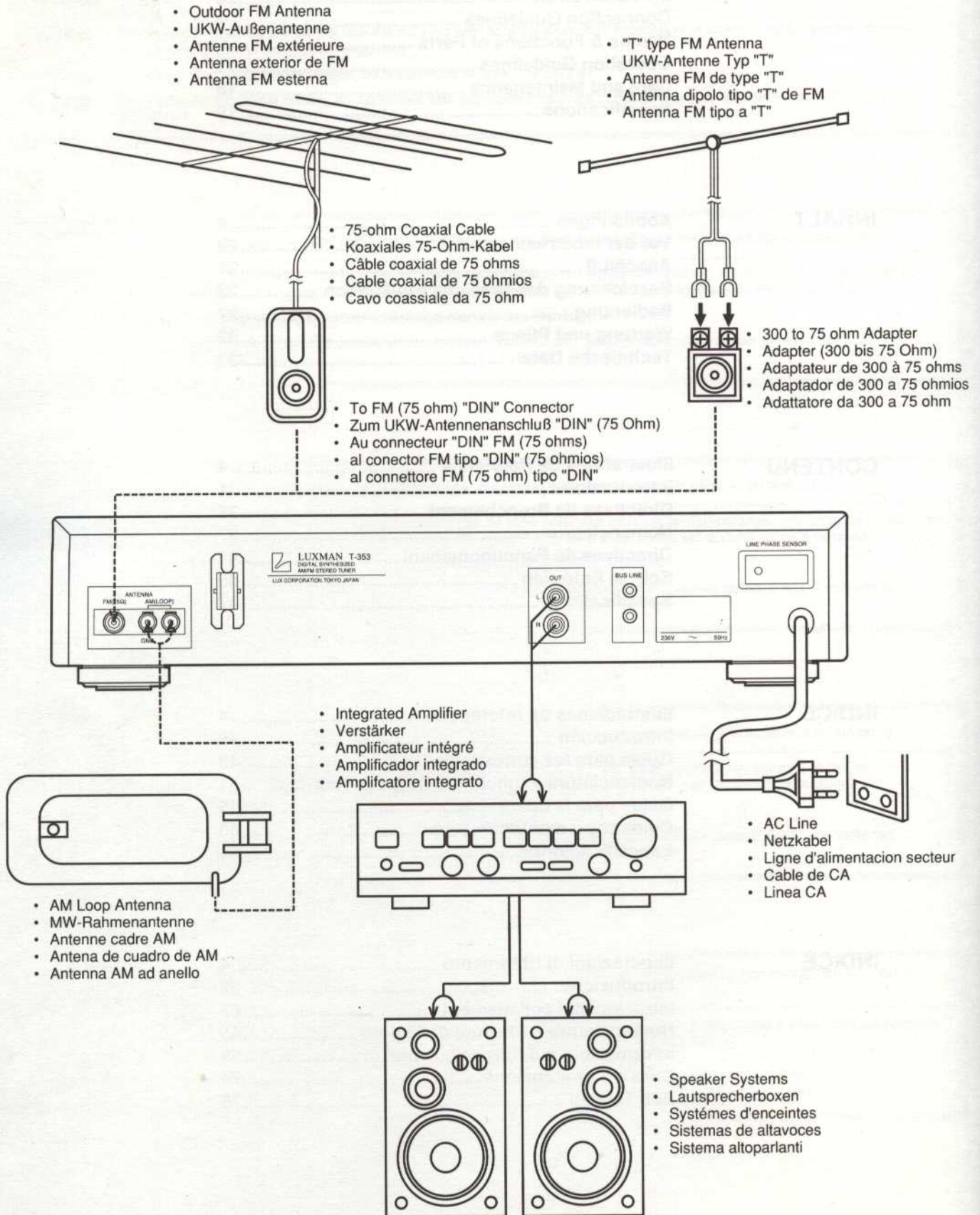
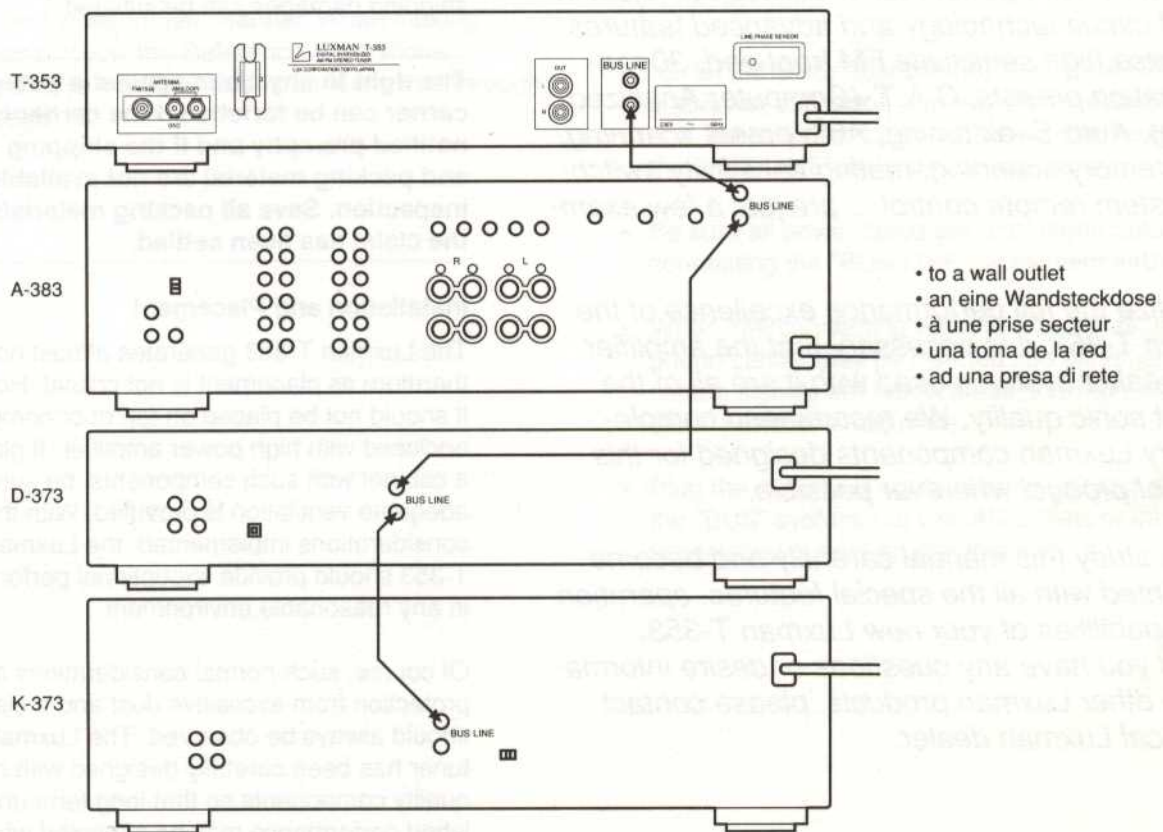

Fig. 2/Abb. 2/III. 2

- System "BUS" and AC cord connections for "BUS" operation. Illustration shows a typical combination example.
- "BUS LINE"-Systemanschlüsse und Netzanschlüsse für den "BUS"-Systembetrieb. Die Abbildung zeigt ein typisches Kombinationsbeispiel.
- Branchements du système "BUS" et du cordon d'alimentation secteur pour une utilisation "BUS". L'illustration indique un exemple de combinaison caractéristique.
- Conexiones del sistema "BUS" y de los cables de alimentación de CA para la operación del sistema "BUS". En la ilustración se muestra un ejemplo de combinación típico.
- Collegamenti del sistema "BUS" e del cavo di alimentazione per l'operazione "BUS". L'illustrazione mostra un esempio di combinazione tipica.



English

Deutsch

Français

Español

Italiano

Introduction

Welcome!

At Luxman, Ultimate Fidelity is a goal we consider most important. Your purchase of this component has told us you feel the same. We take great pride in the long tradition of excellence in sonic quality that the Luxman name represents. Now, as part of that tradition, we welcome you to the growing number of discerning audiophiles who own and operate Luxman products. This manual has been prepared to help you maximize your enjoyment of the outstanding performance and feature capabilities of your new Luxman T-353.

This AM/FM component tuner utilizes the latest in refined circuit technology and advanced features. Low noise high sensitivity FM front end, 30 random station presets, C.A.T. (Computer Analyzed Tuning), Auto-Seek tuning, Auto preset scanning, Auto memory scanning, muting sensitivity switching, system remote control ... are just a few examples.

To realize the full performance excellence of the Luxman T-353, it is necessary that the amplifier and speaker systems used with it are all of the highest sonic quality. We recommend complementary Luxman components designed for this series of product wherever possible.

Please study this manual carefully and become acquainted with all the special features, operation and capabilities of your new Luxman T-353. Should you have any questions or desire information on other Luxman products, please contact your local Luxman dealer.

When You Open the Box

Before any Luxman product leaves the factory it is carefully inspected for physical imperfections as a routine part of Luxman's systematic quality control. This, along with full electrical testing, should insure quality craftsmanship and performance. After you have unpacked the unit, inspect it for any physical damage. Save the shipping carton and all packing materials, as they are essential to reduce to a minimum the possibility of transportation damage, should the product ever need to be shipped again. In the unlikely event that damage has occurred, notify your dealer immediately and request the name of the carrier so that a written claim to cover shipping damages can be initiated.

The right to any claim against a public carrier can be forfeited if the carrier is not notified promptly and if the shipping carton and packing material are not available for inspection. Save all packing materials until the claim has been settled.

Installation and Placement

The Luxman T-353 generates almost no heat, therefore its placement is not critical. However, it should not be placed on top of or completely enclosed with high power amplifier. If placed in a cabinet with such components, be sure adequate ventilation is provided. With these considerations implemented, the Luxman T-353 should provide exceptional performance in any reasonable environment.

Of course, such normal considerations as protection from excessive dust and moisture should always be observed. The Luxman T-353 tuner has been carefully designed with high quality components so that long term undiminished performance may be expected when it is operated in accordance with the instructions provided.

Connection Guidelines

Before Making Connections

It is always wise to ensure that all AC power cords of the various components that you are interconnecting are unplugged from the wall outlets during the hook-up process. This will prevent any inadvertent damage to your speakers or amplifier from incorrect control settings or connections.

Interconnecting Leads

Be sure that left and right channel identification is correct when making interconnections. Most patch cords are colour coded with RED ends for the right channel and BLACK or WHITE ends for the left channel, to make this job easier. In addition, all jacks on the rear of the T-353 have red centres for right channel and white for left channel. When making connections, follow the Reference Illustrations, referring also to the descriptions for items #36 through #43 on page 12.

Connection of the OUTput Jacks

Connect the "OUT" (output) jacks (item #39) of the T-353 to the TUNER IN (input) jacks of your integrated amplifier with the supplied phono type patch cords.

AC Power Cord

Insert the AC plug of the T-353 into appropriate wall outlet.

BUS LINE Jack Connections (refer to illustration on page 5, Fig. 2)

"SYSTEM BUS" uses 2-way commands that operate the Automatic Source Play, Source Select and CD Synchro systems.

- "SYSTEM BUS," identified by the symbol  printed on the carton and owner's manual of the unit, indicates the Luxman models that work with the "BUS LINE" jacks on the rear panel.
- Be sure all power cords are unplugged before connecting the "BUS LINE" jacks (item #40).
- When interconnecting with the other units, the mini phone cables may be inserted into either jack (the control signals are bidirectional, therefore no "IN/OUT" protocol is required).
- Plug the AC power cords of each unit included in the "BUS" system into wall AC outlets or into unswitched outlets on the amplifier.

Connection Guidelines

AM Antenna

An AM loop antenna comes packed with your T-353. Carefully unwrap and mount it to the rear panel and connect leads (see illustrations, page 4).

FM "T" Type Antenna

Included also with your T-353, is an FM "T" type antenna. This type of antenna is simple and practical and will give adequate results in primary signal areas. To use it, unfold it and connect its centre leads to the DIN connector on the rear of the tuner, using the 300 ohm to 75 ohm adapter. The antenna is designed to operate in a horizontal position, and may be attached to a nearby wall.

As shown on page 4, the T-353 is also capable of accommodating other types of cable, including 75-ohm coaxial cable (with DIN connector). These types of cable are for use with outdoor antennas, which will be discussed next.

Outdoor FM Antenna

As stated before, the supplied folded FM "T" type antenna will give satisfactory results in primary signal areas. However, if you are located in a fringe area where signals are weak, then an outdoor antenna will be necessary. Even if you live in a strong signal location, an outdoor directional antenna may be needed to eliminate "multipath" reflections.

Multipath reflections are responsible for much of the distortion and noise associated with poor FM reception. They occur when radio waves from the transmitter bounce off nearby mountains and tall buildings. The reflected waves follow different, more roundabout paths to your tuner and arrive slightly delayed and out of phase with the direct signal (hence, the term "multipath"). This causes distortion in the same manner that "ghost" images are generated on television.

The way to minimize multipath is to use a "beam type" antenna that can be aimed toward the FM transmitter and away from the multipath reflections. The best types of antennas to use are either a "Yagi" or "Log-Periodic" configuration with six or more elements designed expressly for FM reception.

If you want to receive stations from more than one general direction, then you will need a good quality antenna rotor system. This will enable you to point the antenna in the direction giving the least multipath interference, by means of a control box located near the receiver.

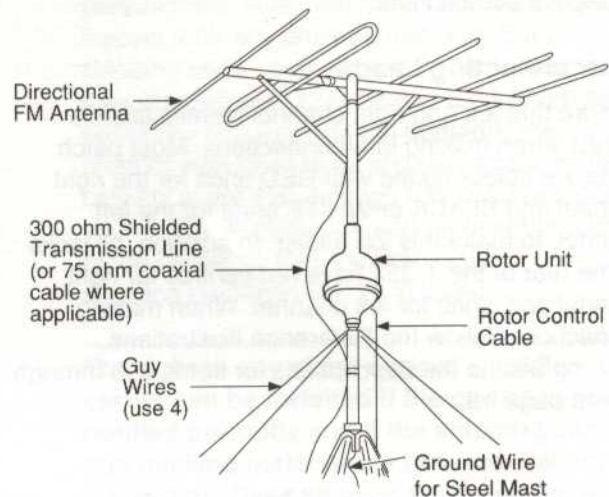

Another important factor is the type of lead-in wire to use. Unshielded lead-in wires, such as 300-ohm twin lead, can act as an omnidirectional antenna, and can cancel the directional benefits of your antenna. Therefore, we recommend using a coaxial 75-ohm cable at the antenna. This shielded cable effectively prevents the lead-in from contributing to multipath distortion.

If you decide to use 75-ohm coaxial cable, we recommend buying cable with DIN type connectors attached. These will fit the FM (75 ohm) terminal on the T-353.

It is considered good practice to connect the antenna mast to an earth ground, both for reasons of safety and noise reduction.

For rural areas, it is recommended to consult a local dealer about installation and lightning arrester protection.

We don't recommend using master antenna systems, such as those found in apartment buildings. Such systems are usually designed expressly for television reception and frequently suppress or reduce the quality of the FM signals before distribution.

Names & Functions of Parts

Front panel

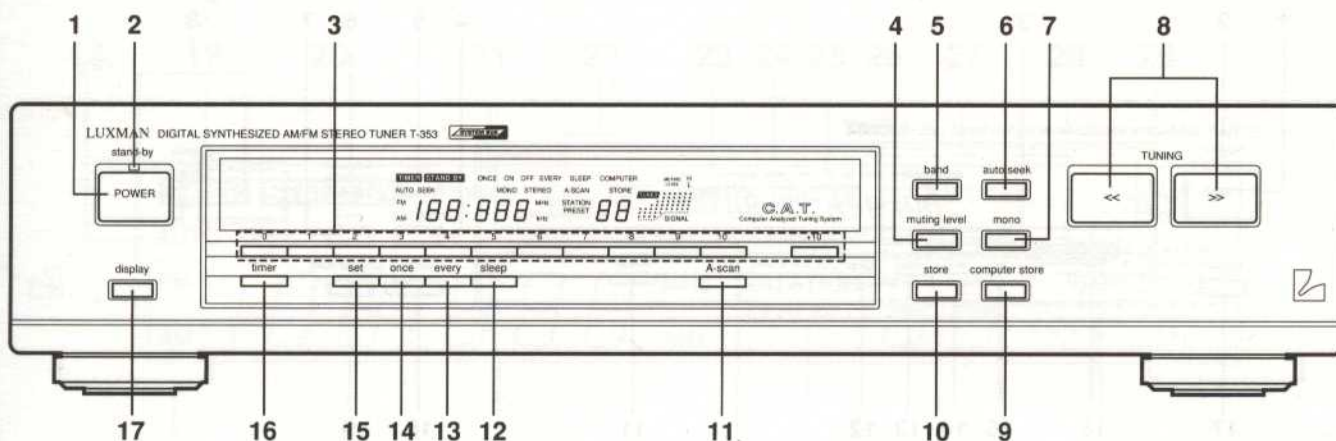

1. "POWER" button

Press "POWER" button to turn power on and off to the unit.

Note:

When the T-353 is connected into a "SYSTEM BUS" set-up, the power button on the amplifier will also turn the T-353 on and off along with all other Bus Line connected components.

2. "stand-by" indicator

Stays lighted when the power button is turned off to show that the remote system is ready to receive a power ON command.

3. Station presets buttons

A total of 30 AM (LW/MW) and/or FM stations may be placed into memory in any random order and recalled for instant play, with these buttons. Select previously stored preset stations by pressing the desired number 1 through 10. For presets 11 through 30, press the +10 button first, then 1 through 10. Each number thus selected will appear in the display just right to the words "STATION PRESET."

4. "muting level" button

Press this button to switch the signal strength in the FM auto-tuning mode. The "MUTING LEVEL H/L" (item #29) indicator on the display shows the selected position—"H"(high) or "L"(Low). When set in the "H" position, the tuner tunes to the strong signal FM stations only. When set in the "L" position, both strong and weak signal FM stations will be tuned in.

Note:

The muting level is switchable only for the FM band.

5. "band" select button

Pressing this button selects either the AM (LW/MW) or FM band.

6. "auto seek" button

When pressed, this button activates the auto seek automatic tuning mode, in conjunction with the "TUNING <</>>" buttons (item #8), for both AM (LW/MW) and FM operation. In addition the "AUTO SEEK" indicator (item #18) will light.

7. "mono" button

This button selects either STEREO or MONO mode for FM listening. It works with the "STEREO/MONO" indicators (item #33).

Note:

This button is functional only when a stereo program is received.