

SERVICE MANUAL

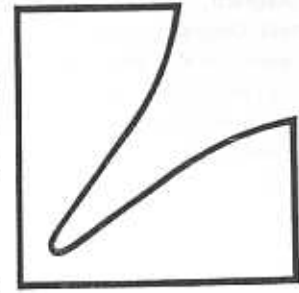

Stereo Integrated Amplifier

LV-111/LV-110

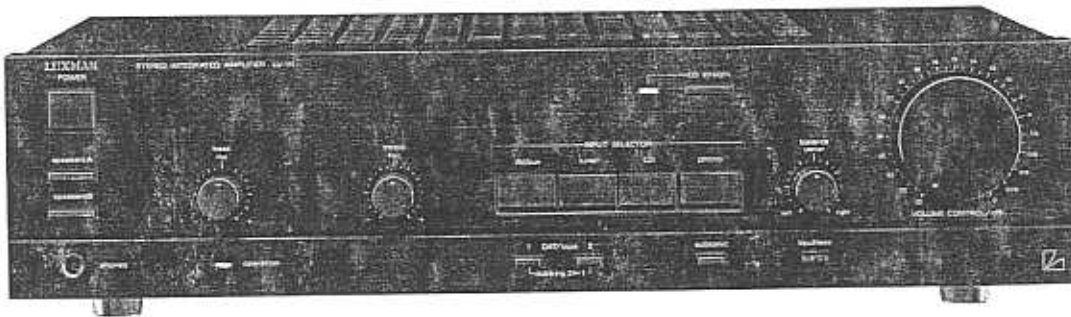

Parts Locations and Disassembly Instructions

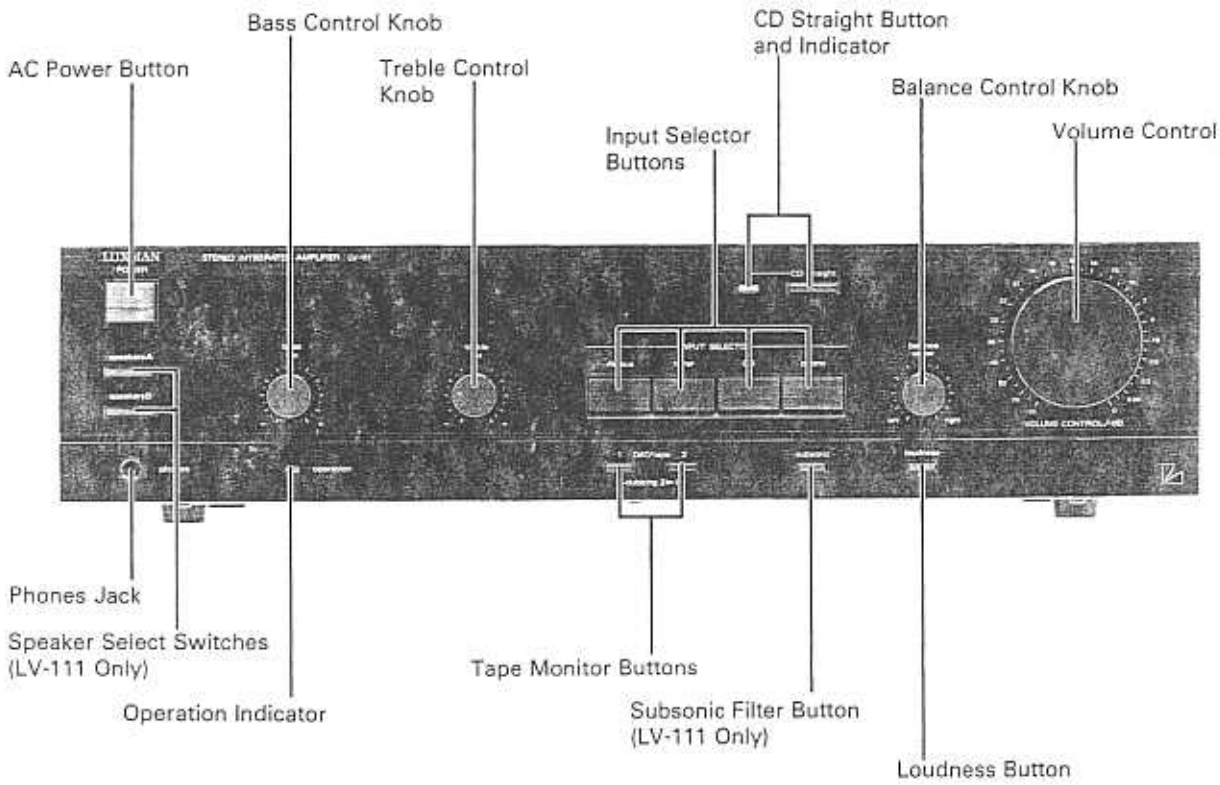

Figure 1

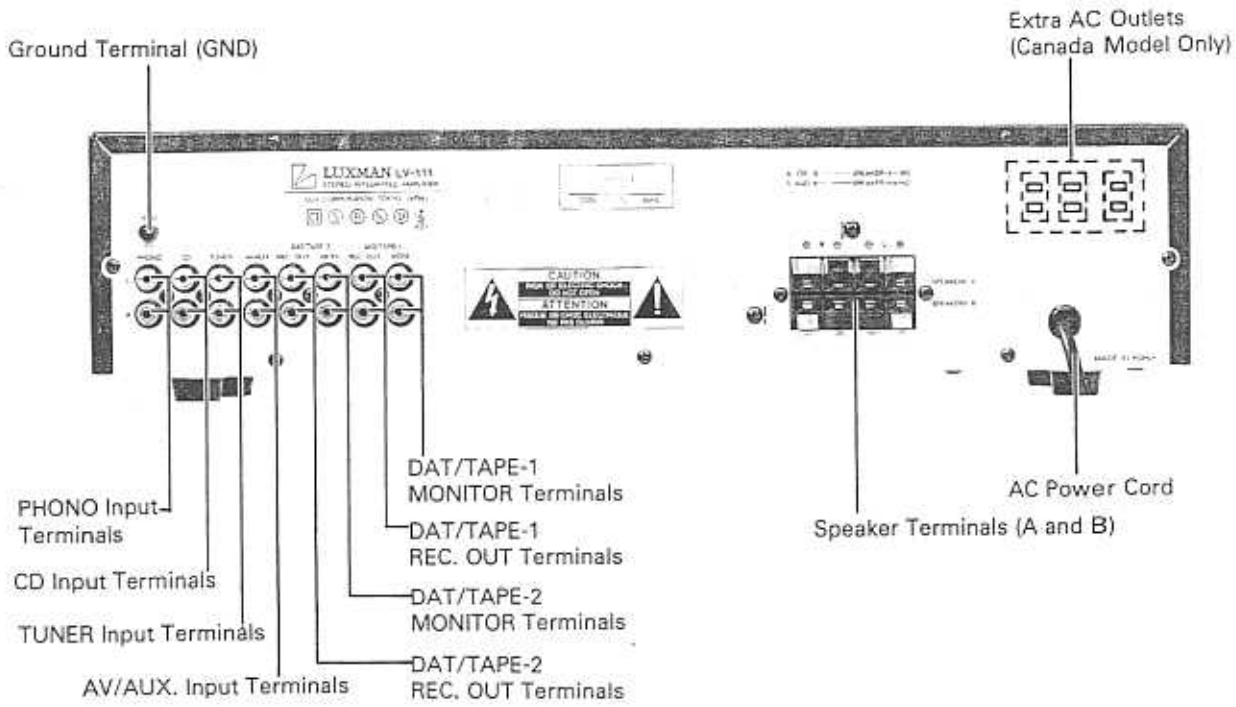

Figure 2

1. Removal of Top Cover

- (1) Remove six screws marked "○" as shown in Figures 3 and 4.
- (2) Pull out the Top Cover in the Direction of the arrow as shown in Figure 3.

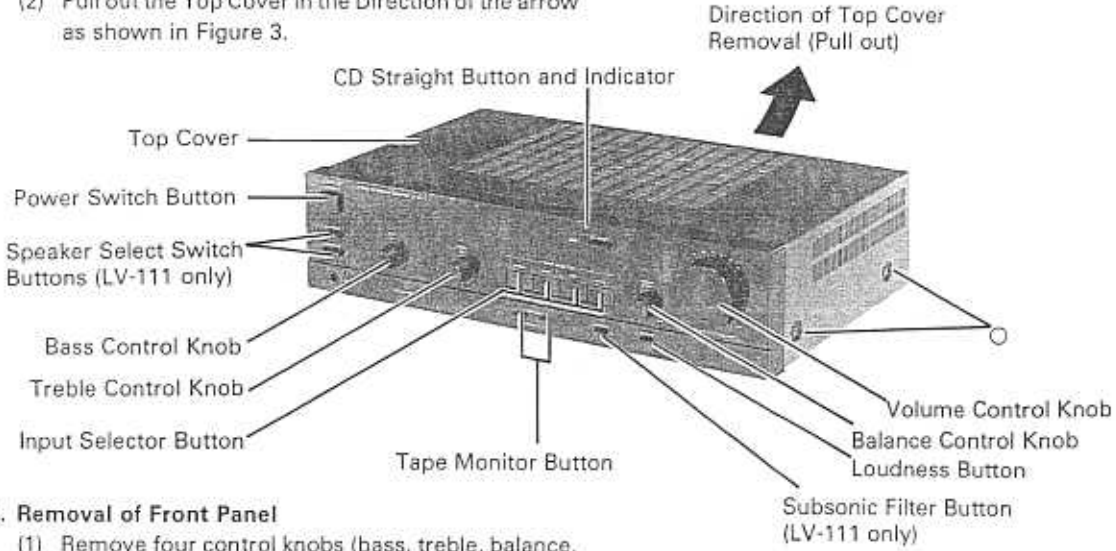

Figure 3

2. Removal of Front Panel

- (1) Remove four control knobs (bass, treble, balance, volume) as shown in Figure 3.
- (2) Remove six screws marked "△" as shown in Figures 4 and 5.

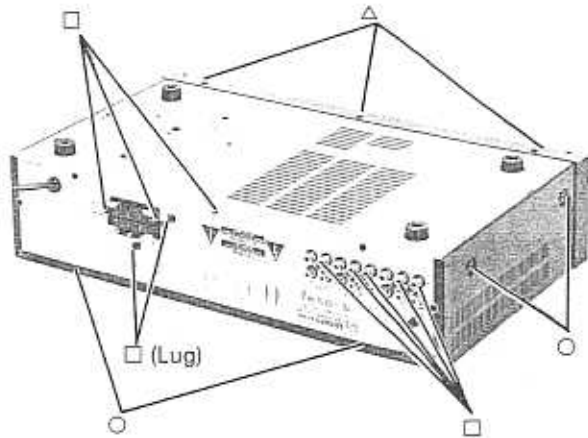

Figure 4

3. Removal of Power Switch P.C. Board

- (1) Remove the Power Switch knob as shown in Figure 3.
- (2) Remove two screws marked "※" as shown in Figure 6.
- (3) Disconnect all wires from the P.C. Board.

4. Removal of Speaker Switch P.C. Board

- (1) Remove two speaker select switch knobs as shown in Figure 3. (LV-111 only)
- (2) Remove a screw marked "□" as shown in Figure 6. (LV-111 only)
- (3) Remove a stopper securing the phones jack marked "◎" as shown in Figure 6.
- (4) Disconnect all wires from the P.C. Board.

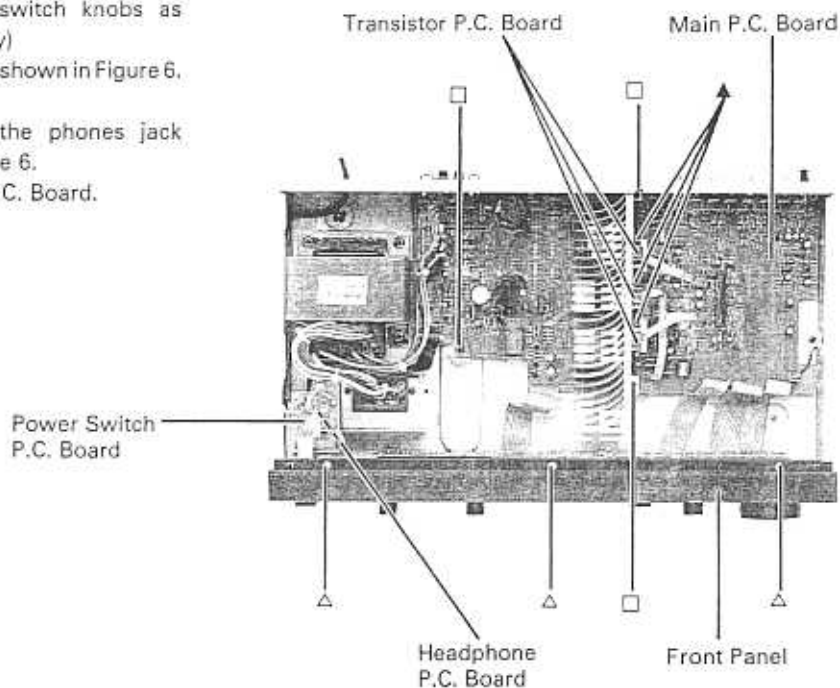

Figure 5

5. Removal of Control P.C. Board

- (1) Remove four knobs (Input Selector), and five knobs (Tape Monitor, CD Straight Switch, Subsonic Filter Switch (LV-111 only), Loudness Switch) as shown in Figure 3.
- (2) Remove four nuts and four washers (Nut A, Washer A, Nut B, Washer B, Nut C, Washer C, Nut D, Washer D) as shown in Figure 6.
- (3) Remove 10 screws marked "●" as shown in Figure 6.
- (4) Disconnect all wires from the P.C. Board.

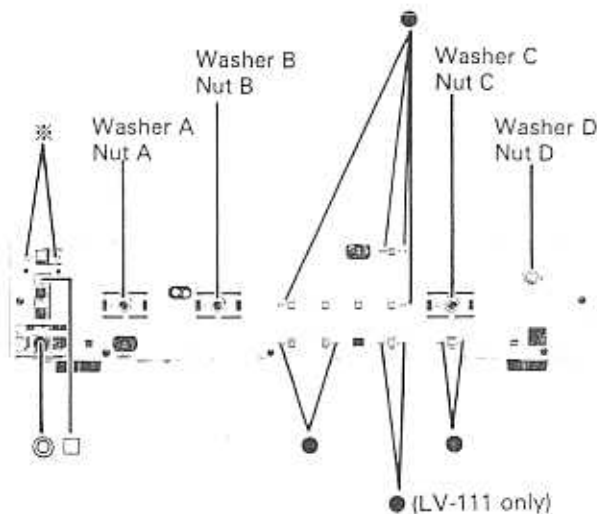

Figure 6

6. Removal of Transistor P.C. Boards

- (1) Remove 3 screws marked "▲" as shown in Figure 5.
- (2) Disconnect all wires from the P.C. Boards.

7. Removal of Main P.C. Board

- (1) Remove 11 screws and two lugs marked "□" as shown in Figures 4 and 5.
To remove the lugs on the rear cover, remove the screws first, then straighten the lugs, and pull them.
- (2) Disconnect all wires from the P.C. Board.

8. Removal of Heat Sink from Main P.C. Board

- (1) Remove two screws from the foil side of the Main P.C. Board.
- (2) Disconnect seven transistors connected with the heat sink.

Electrical Parts List

Resistor: Carbon resistors under 1/4 watts are not mentioned in the parts list, please confirm them by schematic diagram.
uF=microfarads, pF=picofarads

Abbreviations				Symbol No.	Part No.	Description		
RES. = Resistor	CAP. = Capacitor							
C.F. = Carbon Film	ELY. = Electrolytic							
M.F. = Metal Film	CER. = Ceramic							
M.O. = Metal Oxide Film	MYL. = Mylar							
M.P. = Metal Plate	TAN. = Tantalum							
CMT. = Cement Resistor	POLY. = Polystyrol							
TR. = Transistor	PP. = Polypropylene							
TRANS. = Transformer	PLT. = Polyethylene							
CP. = Chip	STR. = Styrene							
	M-PL. = M-Plastic							
Symbol No.	Part No.	Description						
Main P. C. Board								
IC's								
IC101	51T72167F01	M5220L						
IC301	51T68833F02	STK3042M-3						
IC501	51T68833F01	L78M15						
Transistors								
Q301	48T52979F01	2SD600						
Q302	48T52979F01	2SD600						
Q303	48T68663F01	2S8631						
Q304	48T68663F01	2S8631						
* Q305	48T45382F01	2SD1047						
* Q306	48T45382F01	2SD1047						
* Q307	48T45381F01	2S8817						
* Q308	48T45381F01	2S8817						
Q341	48T81102F01	2SA1015						
Q342	48T81102F01	2SA1015						
Q343	48T81101F01	2SC1815						
Q344	48T81101F01	2SC1815						
Q345	48T81101F01	2SC1815						
Q346	48T81101F01	2SC1815						
Q347	48T81102F01	2SA1015						
Q348	48T81102F01	2SA1015						
Q401	48T81101F01	2SC1815						
Q402	48T81101F01	2SC1815						
Q403	48T81102F01	2SA1015						
Q405	48T81101F01	2SC1815						
Q406	48T81101F01	2SC1815						
Q407	48T43015U01	2SC2120						
Diodes								
D301	48E04616S01	Silicon IN4148						
D302	48E04616S01	Silicon IN4148						
D303	48E04616S01	Silicon IN4148						
D304	48E04616S01	Silicon IN4148						
D305	48E04616S01	Silicon IN4148						
D306	48E04616S01	Silicon IN4148						
D307	48E04616S01	Silicon IN4148						
D308	48E04616S01	Silicon IN4148						
D401	48E04616S01	Silicon IN4148						
D402	48E04616S01	Silicon IN4148						
D403	48T44992F01	Silicon DS135D						
D501	48E04617S01	Silicon 3D2-61						
D502	48E04617S01	Silicon 3D2-61						
D503	48E04617S01	Silicon 3D2-61						
D504	48E04617S01	Silicon 3D2-61						
D505	48T44992F01	Silicon DS135D						
D506	48T44992F01	Silicon DS135D						
D507	48T44992F01	Silicon DS135D						
D508	48T44992F01	Silicon DS135D						
D509	48E01750S01	Zener GZA15Y						
D510	48E01750S01	Zener GZA15Y						
D511	48E01752S01	Zener GZA18Y						
D512	48E01752S01	Zener GZA18Y						
D513	48T44992F01	Silicon DS135D						
Coils/Relay								
L301	24E04618S01	Air Coil L/R						
L302	24E04618S01	Air Coil L/R						
RY301	80E04619S01	Relay						
Jacks								
JK101	09E04620S01	RCA Jack (CD/ PHONO/TUNER)						
JK102	09E04620S01	RCA Jack (AUX/ REC2/MON2)						
JK103	09E04621S01	RCA Jack (REC1/ DAT)						

NOTE: The power transistors marked by * (Q305, Q306, Q307 and Q308) should be used with the insulation sheets 14E04788S01.

Symbol No.	Part No.	Description		Symbol No.	Part No.	Description	
Capacitors							
C101	21E04622S05	CER., 68pF		C321	23E04624S03	ELY., 22 μ F/50V	
C102	21E04622S05	CER., 68pF		C322	23E04624S03	ELY., 22 μ F/50V	
C103	21E04623S01	CER., 220pF		▲ C323	21E04629S02	CER., 2200pF	
C104	21E04623S01	CER., 220pF		△ C323	21E04629S02	CER., 2200pF	
C105	23E04624S01	ELY., 2.2 μ F/50V		● C323	21E04631S01	CER., 0.01 μ F	
C106	23E04624S01	ELY., 2.2 μ F/50V		○ C323	21E04631S01	CER., 0.01 μ F	
C107	23E04625S01	ELY., 47 μ F/16V		▲ C324	21E04629S02	CER., 2200pF	
C108	23E04625S01	ELY., 47 μ F/16V		△ C324	21E04629S02	CER., 2200pF	
C109	08E04626S01	MYL., 0.056 μ F		● C324	21E04631S01	CER., 0.01 μ F	
C110	08E04626S01	MYL., 0.056 μ F		○ C324	21E04631S01	CER., 0.01 μ F	
C111	08E04626S02	MYL., 0.015 μ F		▲ C325	21E04629S02	CER., 2200pF	
C112	08E04626S02	MYL., 0.015 μ F		△ C325	21E04629S02	CER., 2200pF	
C113	23E04624S02	ELY., 0.47 μ F/50V		● C325	21E04631S01	CER., 0.01 μ F	
C114	23E04624S02	ELY., 0.47 μ F/50V		○ C325	21E04631S01	CER., 0.01 μ F	
C115	23E04627S01	ELY., 47 μ F/25V		▲ C325	21E04629S02	CER., 2200pF	
C116	23E04627S01	ELY., 47 μ F/25V		△ C326	21E04629S02	CER., 2200pF	
● C117	21E04734S02	CER., 680pF		● C326	21E04631S01	CER., 0.01 μ F	
○ C117	21E04734S02	CER., 680pF		○ C326	21E04631S01	CER., 0.01 μ F	
● C118	21E04734S02	CER., 680pF		C327	23E04627S02	ELY., 22 μ F/25V	
○ C118	21E04734S02	CER., 680pF		C328	23E04627S02	ELY., 22 μ F/25V	
C131	21E04623S02	CER., 680pF		C341	21E04632S01	CER., 2200pF	
C132	21E04623S02	CER., 680pF		C342	21E04632S01	CER., 2200pF	
C133	21E04623S02	CER., 680pF		C343	21E04632S01	CER., 2200pF	
C134	21E04623S02	CER., 680pF		C344	21E04632S01	CER., 2200pF	
C135	21E04623S02	CER., 680pF		C345	23E04625S02	ELY., 10 μ F/16V	
C136	21E04623S02	CER., 680pF		C346	23E04625S02	ELY., 10 μ F/16V	
C137	21E04623S02	CER., 680pF		C347	23E04625S02	ELY., 10 μ F/16V	
C138	21E04623S02	CER., 680pF		C348	23E04625S02	ELY., 10 μ F/16V	
C139	21E04623S02	CER., 680pF		C401	23E04625S03	ELY., 220 μ F/16V	
C140	21E04623S02	CER., 680pF		C402	23E04625S03	ELY., 220 μ F/16V	
C301	21E04623S03	CER., 330pF		C403	23E04633S01	ELY., 0.47 μ F/50V	
C302	21E04623S03	CER., 330pF		C404	23E04625S04	ELY., 33 μ F/16V	
C303	23E04624S01	ELY., 2.2 μ F/50V		C501	21E04634S01	CER., 0.047 μ F	
C304	23E04624S01	ELY., 2.2 μ F/50V		C502	21E04634S01	CER., 0.047 μ F	
C305	21E04628S01	CER., 470pF		C503	21E04634S01	CER., 0.047 μ F	
C306	21E04628S01	CER., 470pF		C504	21E04634S01	CER., 0.047 μ F	
C307	21E04629S01	CER., 1500pF		○ C505	23E04635S01	ELY., 4700 μ F/50V	
C308	21E04629S01	CER., 1500pF		△ C505	23E04635S01	ELY., 4700 μ F/50V	
C309	21E04622S02	CER., 47pF		● C505	23E04635S02	ELY., 6800 μ F/50V	
C310	21E04622S02	CER., 47pF		▲ C505	23E04635S02	ELY., 6800 μ F/50V	
C311	08E04630S01	M-PL., 0.1 μ F		○ C506	23E04635S01	ELY., 4700 μ F/50V	
C312	08E04630S01	M-PL., 0.1 μ F		△ C506	23E04635S01	ELY., 4700 μ F/50V	
C313	21E04622S06	CER., 33pF		● C506	23E04635S02	ELY., 6800 μ F/50V	
C314	21E04622S06	CER., 33pF		▲ C506	23E04635S02	ELY., 6800 μ F/50V	
C315	21E04628S02	CER., 100pF		C507	23E04636S01	ELY., 2200 μ F/25V	
C316	21E04628S02	CER., 100pF		C508	23E04624S01	ELY., 2.2 μ F/50V	
C317	21E04628S02	CER., 100pF		C611	21E04637S01	CER., 0.022 μ F	
C318	21E04628S02	CER., 100pF		C612	21E04637S01	CER., 0.022 μ F	
C319	08E04626S03	MYL., 0.047 μ F		C613	21E04637S01	CER., 0.022 μ F	
C320	08E04626S03	MYL., 0.047 μ F		▲ C614	21E04629S02	CER., 2200pF	

Notes : ● : For LV-111 multivoltage model (AD), ▲ : For LV-111 Canadian model (UQ),
○ : For LV-110 multivoltage model (AD), △ : For LV-110 Canadian model (UQ), Others : Common.

Symbol No.	Part No.	Description			Symbol No.	Part No.	Description		
△ C614	21E04629S02	CER., 2200pF			Control P. C. Board				
● C614	21E04631S03	CER., 0.022 μ F			IC/Diodes				
○ C614	21E04631S03	CER., 0.022 μ F			IC201	51T65380F01	BA4558HT		
▲ C615	21E04629S02	CER., 2200pF			D201	48E04647S01	Zener GZA11Y		
△ C615	21E04629S02	CER., 2200pF			D202	48E04647S01	Zener GZA11Y		
● C615	21E04631S03	CER., 0.022 μ F			LD201	48E04648S01	LED (Red)		
○ C615	21E04631S03	CER., 0.022 μ F			LD202	48E04648S01	LED (Red)		
C616	21E04637S01	CER., 0.022 μ F			Switches				
● C617	21E04638S01	CER., 2200pF			SW201	40E04649S01	Push Switch (Function)		
○ C617	21E04638S01	CER., 2200pF			SW202	40E04650S01	Push Switch (CD Straight)		
● C618	21E04637S02	CER., 0.047 μ F			SW203	40E04651S01	Push Switch (Monitor)		
○ C618	21E04637S02	CER., 0.047 μ F			SW204	40E04652S01	Push Switch (Loudness)		
● C619	21E04637S02	CER., 0.047 μ F			● SW205	40E04652S01	Push Switch (Subsonic)		
○ C619	21E04637S02	CER., 0.047 μ F			▲ SW205	40E04652S01	Push Switch (Subsonic)		
Resistors					Capacitors				
R317	06E04639S01	M.O., 33 ohm 1W			C201	23E04653S01	ELY., 2.2 μ F/50V		
R318	06E04639S01	M.O., 33 ohm 1W			C202	23E04653S01	ELY., 2.2 μ F/50V		
R319	06E04639S01	M.O., 33 ohm 1W			C203	21E04622S02	CER., 47pF		
R320	06E04639S01	M.O., 33 ohm 1W			C204	21E04622S02	CER., 47pF		
R327	06E04639S02	M.O., 10 ohm 1W			C205	21E04622S02	CER., 47pF		
R328	06E04639S02	M.O., 10 ohm 1W			C206	21E04622S02	CER., 47pF		
R329	06E04640S01	M.O., 10 ohm 2W			C207	21E04622S04	CER., 15pF		
R330	06E04640S01	M.O., 10 ohm 2W			C208	21E04622S04	CER., 15pF		
R331	06E04639S03	M.O., 150 ohm 1W			C209	23E04653S02	ELY., 0.47 μ F/50V		
R332	06E04639S03	M.O., 150 ohm 1W			C210	23E04653S02	ELY., 0.47 μ F/50V		
R333	06E04639S04	M.O., 120 ohm 1W			C211	23E04653S03	ELY., 4.7 μ F/50V		
R334	06E04639S04	M.O., 120 ohm 1W			C212	23E04653S03	ELY., 4.7 μ F/50V		
R418	06E04641S01	C.F., 88 ohm 1/2W			C213	23E04653S03	ELY., 4.7 μ F/50V		
R501	06E04640S02	M.O., 2.2k ohm 2W			C214	23E04653S03	ELY., 4.7 μ F/50V		
R502	06E04640S02	M.O., 2.2k ohm 2W			C215	08E04654S01	M-PL., 0.039 μ F		
R503	06E04640S03	M.O., 2.7k ohm 2W			C216	08E04654S01	M-PL., 0.039 μ F		
R504	06E04640S03	M.O., 2.7k ohm 2W			C217	08E04654S02	M-PL., 0.18 μ F		
MP301	17E04642S01	CMT., 0.22 ohm 5.0W			C218	08E04654S02	M-PL., 0.18 μ F		
MP302	17E04642S01	CMT., 0.22 ohm 5.0W			C219	08E04654S03	M-PL., 6800pF		
VR301	18E04643S01	Semi Fixed Volume 2.2K			C220	08E04654S03	M-PL., 6800pF		
VR302	18E04643S01	Semi Fixed Volume 2.2K			Miscellaneous				
● F501	65E04644S01	Fuse 250V 0.16A							
○ F501	65E04644S01	Fuse 250V 0.16A							
▲ F501	65E04645S01	Fuse 250V 500mA							
△ F501	65E04645S01	Fuse 250V 500mA							
● F502	65E04646S01	Fuse 250V 5A							
○ F502	65E04646S01	Fuse 250V 5A							

Notes : ● : For LV-111 multivoltage model (AD), ▲ : For LV-111 Canadian model (UQ),
 ○ : For LV-110 multivoltage model (AD), △ : For LV-110 Canadian model (UQ), Others : Common.

Symbol No.	Part No.	Description			Symbol No.	Part No.	Description		
C221	08E04654S04	M-PL., 0.033 μ F			Power Switch P. C. Board				
C222	08E04654S04	M-PL., 0.033 μ F			Capacitors/Fuses/Switch				
C223	23E04655S01	ELY., 100 μ F/25V			C601	08E04663S01	Line CAP., AC400V103P		
C224	23E04655S01	ELY., 100 μ F/25V			C602	08E04663S01	Line CAP., AC400V103P		
C231	08E04654S05	M-PL., 0.015 μ F			● F601	65E04664S01	Fuse 250V 2A		
C232	08E04654S05	M-PL., 0.015 μ F			○ F601	65E04664S01	Fuse 250V 2A		
C233	08E04656S01	STR., 820pF			▲ F601	65E04665S01	Fuse 125V 3.15A		
C234	08E04656S01	STR., 820pF			△ F601	65E04666S01	Fuse 125V 2.5A		
● C240	21E04637S01	CER., 0.022pF			SW601	40E04667S01	Push Switch (Power)		
○ C240	21E04637S01	CER., 0.022pF			Transistor P. C. Board (Protector)				
● C241	21E04632S02	CER., 4700pF			Transistor				
○ C241	21E04632S02	CER., 4700pF			Q404	48T81101F01	2SC1815		
● C251	08E04654S06	M-PL., 0.27 μ F			Transistor P. C. Board (L)				
▲ C251	08E04654S06	M-PL., 0.27 μ F			Transistor				
● C252	08E04654S06	M-PL., 0.27 μ F			Q311	48T81101F01	2SC1815		
▲ C252	08E04654S06	M-PL., 0.27 μ F			Transistor P. C. Board (R)				
Resistors					Transistor				
VR201	18E04657S01	Rotary Volume 100KB (Master)			Q312	48T81101F01	2SC1815		
VR202	18E04658S01	Rotary Volume 250KW (Balance)			Miscellaneous				
VR203	18E04659S01	Rotary Volume 50KC (Tone)			▲ T601	25E04681S01	TRANS., Power EI-85 T50C		
VR204	18E04659S01	Rotary Volume 50KC (Tone)			● T601	25E04681S02	TRANS., Power EI-85 T50M		
Headphones P. C. Board					△ T601	25E04682S01	TRANS., Power EI-85 T45C		
Resistors/Switches/Jacks					○ T601	25E04682S02	TRANS., Power EI-85 T45M		
R601	06E04640S04	M.O., 270 ohm 2W			Notes:				
R602	06E04640S04	M.O., 270 ohm 2W			● : For LV-111 multivoltage model (AD), ▲ : For LV-111 Canadian model (UQ),				
● SW602	40E04660S01	Push Switch (Speaker A,B)			○ : For LV-110 multivoltage model (AD), △ : For LV-110 Canadian model (UQ), Others : Common.				
▲ SW602	40E04660S01	Push Switch (Speaker A,B)							
● JK601	09E04661S01	Jack 6.3 (Headphone)							
▲ JK601	09E04661S01	Jack 6.3 (Headphone)							
○ JK601	09E04662S01	Jack 6.3 (Headphone)							
△ JK601	09E04662S01	Jack 6.3 (Headphone)							

Notes: ● : For LV-111 multivoltage model (AD), ▲ : For LV-111 Canadian model (UQ),
○ : For LV-110 multivoltage model (AD), △ : For LV-110 Canadian model (UQ), Others : Common.

Parts List by the Destination

Symbol No.	Description	POWER SOURCE			
		LV-111		LV-110	
		AD ● 220V	UQ ▲ 120V	ADO 220V	UQ △ 120V
C117	Capacitor	21E04734S02	Not Used	21E04734S02	Not Used
C118	Capacitor	21E04734S02	Not Used	21E04734S02	Not Used
C240	Capacitor	21E04637S01	Not Used	21E04637S01	Not Used
C241	Capacitor	21E04632S02	Not Used	21E04632S02	Not Used
C251	Capacitor	08E04654S06	08E04654S06	Not Used	Not Used
C252	Capacitor	08E04654S06	08E04654S06	Not Used	Not Used
C323	Capacitor	21E04631S01	21E04629S02	21E04631S01	21E04629S02
C324	Capacitor	21E04631S01	21E04629S02	21E04631S01	21E04629S02
C325	Capacitor	21E04631S01	21E04629S02	21E04631S01	21E04629S02
C326	Capacitor	21E04631S01	21E04629S02	21E04631S01	21E04629S02
C505	Capacitor	23E04635S02	23E04635S02	23E04635S01	23E04635S01
C506	Capacitor	23E04635S02	23E04635S02	23E04635S01	23E04635S01
C614	Capacitor	21E04631S02	21E04629S02	21E04631S02	21E04629S02
C615	Capacitor	21E04631S02	21E04629S02	21E04631S02	21E04629S02
C617	Capacitor	21E04638S01	Not Used	21E04638S01	Not Used
C618	Capacitor	21E04637S02	Not Used	21E04637S02	Not Used
C619	Capacitor	21E04637S02	Not Used	21E04637S02	Not Used
SW205	Switch	40E04652S01	40E04652S01	Not Used	Not Used
SW602	Switch	40E04660S01	40E04660S01	Not Used	Not Used
JK601	Jack	09E04661S01	09E04661S01	09E04662S01	09E04662S01
F501	Fuse	65E04644S01	65E04645S01	65E04644S01	65E04645S01
F502	Fuse	65E04646S01	Not Used	65E04646S01	Not Used
F601	Fuse	65E04664S01	65E04665S01	65E04664S01	65E04666S01
T601	Transformer	25E04681S02	25E04681S01	25E04682S02	25E04682S01
2	Front Panel Assy	64E04669S01	64E04669S01	64E04670S01	64E04670S01
6	Knob 50, Speaker	36E04674S01	36E04674S01	Not Used	Not Used
16	AC Outlet	Not Used	09E04685S01	Not Used	09E04685S01
17	AC Cord	28E04687S01	28E04686S01	28E04687S01	28E04686S01
19	Back Panel	15E04689S02	15E04689S01	15E04690S02	15E04690S01
21	Rivet	05E04709S01	Not Used	05E04709S01	Not Used
22	Insulation Sheet	14E04692S01	Not Used	14E04692S01	Not Used
23	Lug	29E04693S01	Not Used	29E04693S01	Not Used
24	Cover	15E04694S01	Not Used	15E04694S01	Not Used
25	Switch	40E04695S01	Not Used	40E04695S01	Not Used
26	Contact	09E04696S01	Not Used	09E04696S01	Not Used
27	Shield Plate	07E04697S01	Not Used	07E04697S01	Not Used
35	Screw	03E04704S01	Not Used	03E04704S01	Not Used
37	Screw	03E04704S02	Not Used	03E04704S02	Not Used
101	Packing Carton	56E04698S01	56E04698S01	56E04698S02	56E04698S02
111	Warranty Card	Not Used	68P44370P63	Not Used	68P44370P63

Cabinet Assembly Parts List

Symbol No.	Index	Part No.	Description	Symbol No.	Index	Part No.	Description		
●	1	2-B	15E04688S01	Cabinet, Top	○	25	3-D	40E04695S01	Switch, Voltage Selector
▲	2	5-C	64E04689S01	Ass'y., Front Panel	●	26	3-D	09E04696S01	Contact, Voltage Selector Switch
○	2	5-C	64E04670S01	Ass'y., Front Panel	○	26	3-D	09E04696S01	Contact, Voltage Selector Switch
△	2	5-C	64E04670S01	Ass'y., Front Panel	●	27	2-D	07E04697S01	Plate, Shield
	3	4-C	36E04671S01	Knob 50, Function	○	27	2-D	07E04697S01	Plate, Shield
	4	5-C	36E04672S01	Knob 50, Loudness		28	3-G	07E04710S01	Holder for TR PCB
	5	4-A	36E04673S01	Knob 50, Power		31		03E04701S01	Screw, Taptite, 3 × 8
●	6	4-A	36E04674S01	Knob 50, Speaker		32		03E04702S02	Screw, Taptite, 4 × 10
▲	6	4-A	36E04674S01	Knob 50, Speaker		33		03E04702S01	Screw, Taptite, 4 × 8
	7	4-C	36E04675S01	Knob 50, CD		34	4-B	03E04703S01	Screw, Taptite, 3 × 8
	8	5-A	36E04676S01	Knob 21, Main Volume	●	35	5-G	03E04704S01	Screw, Taptite
	9		36E04677S01	Knob 21, Tone/Balance	○	35	5-G	03E04704S01	Screw, Taptite
	10		75E04678S01	Foot, Back		36		03E04705S01	Screw, F-Lock, 3 × 6
	11		75E04679S01	Foot, Front	●	37	2-D	03E04704S02	Screw, Taptite, 3 × 10
	12		43E04684S01	Spacer, Small	○	37	2-D	03E04704S02	Screw, Taptite, 3 × 10
	13	5-E	43E04680S01	Spacer, Large		38	2-H	03E04706S01	Screw
	14	1-E	04E04708S01	Nut, Flange		39	4-F	03E04704S03	Screw, Taptite 2.6 × 8
	15		29E04683S01	Lug		40	4-G	03E04707S01	Screw, Sems 3 × 10
▲	16	1-G	09E04685S01	Outlet, AC					
△	16	1-G	09E04685S01	Outlet, AC					
▲	17	1-H	28E04686S01	Cord, AC					
△	17	1-H	28E04686S01	Cord, AC					
●	17	1-H	28E04687S01	Cord, AC					
○	17	1-H	28E04687S01	Cord, AC					
	18	1-G	43E04688S01	Bushing, Cord					
▲	19	1-F	15E04689S01	Panel, Back					
●	19	1-F	15E04689S02	Panel, Back					
△	19	1-F	15E04690S01	Panel, Back					
○	19	1-F	15E04690S02	Panel, Back					
	20	5-G	75E04691S01	Cushion					
●	21	2-C	05E04709S01	Rivet, Nylon					
○	21	2-C	05E04709S01	Rivet, Nylon					
●	22	3-B	14E04692S01	Sheet, Insulation					
○	22	3-B	14E04692S01	Sheet, Insulation					
●	23	5-G	29E04693S01	Lug					
○	23	5-G	29E04693S01	Lug					
●	24	5-E	15E04694S01	Cover					
○	24	5-E	15E04694S01	Cover					
●	25	3-D	40E04695S01	Switch, Voltage Selector					

Notes : ● : For LV-111 multivoltage model (AD), ▲ : For LV-111 Canadian model (UQ),
○ : For LV-110 multivoltage model (AD), △ : For LV-110 Canadian model (UQ), Others : Common.

Exploded View (Cabinet)

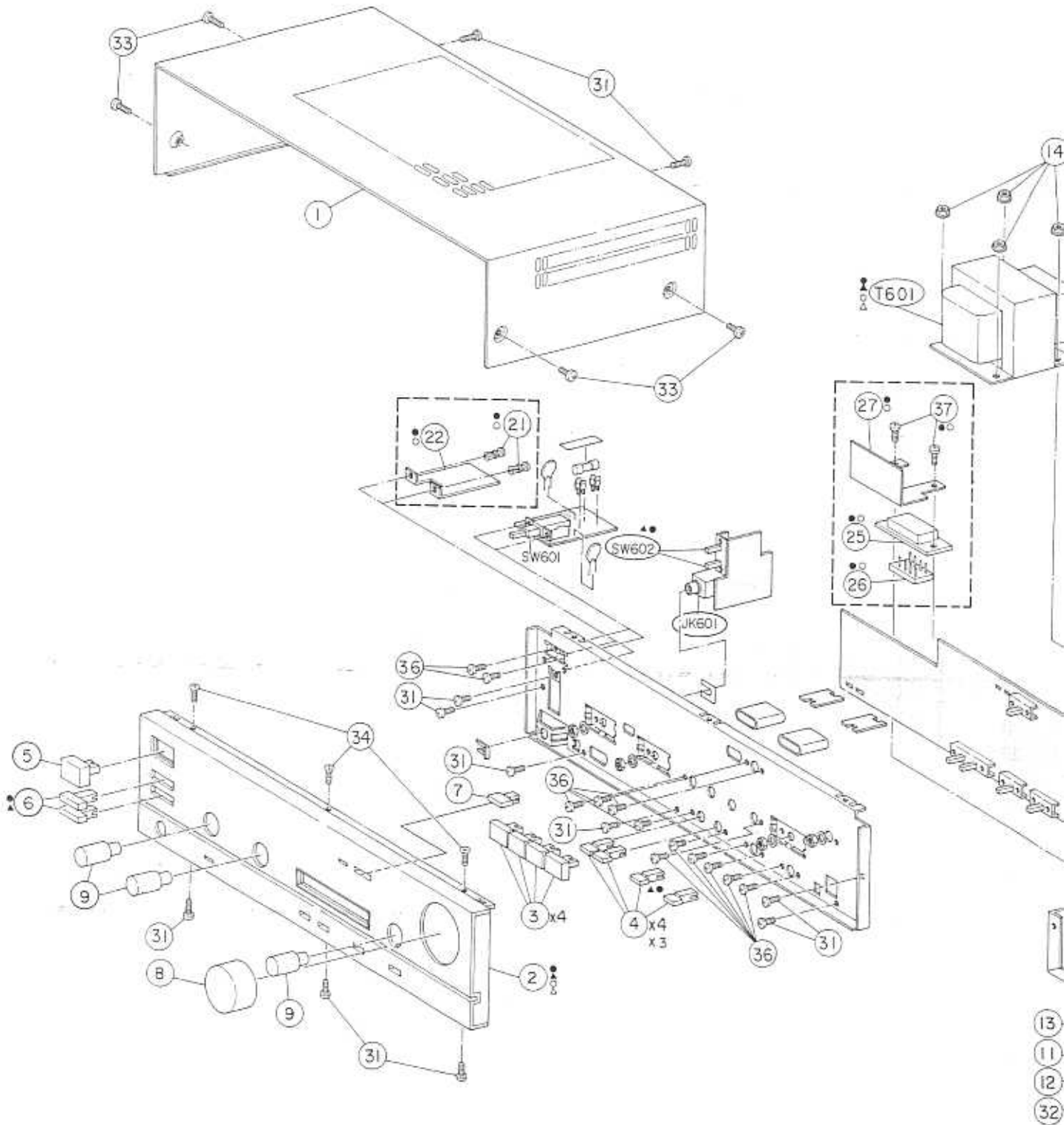

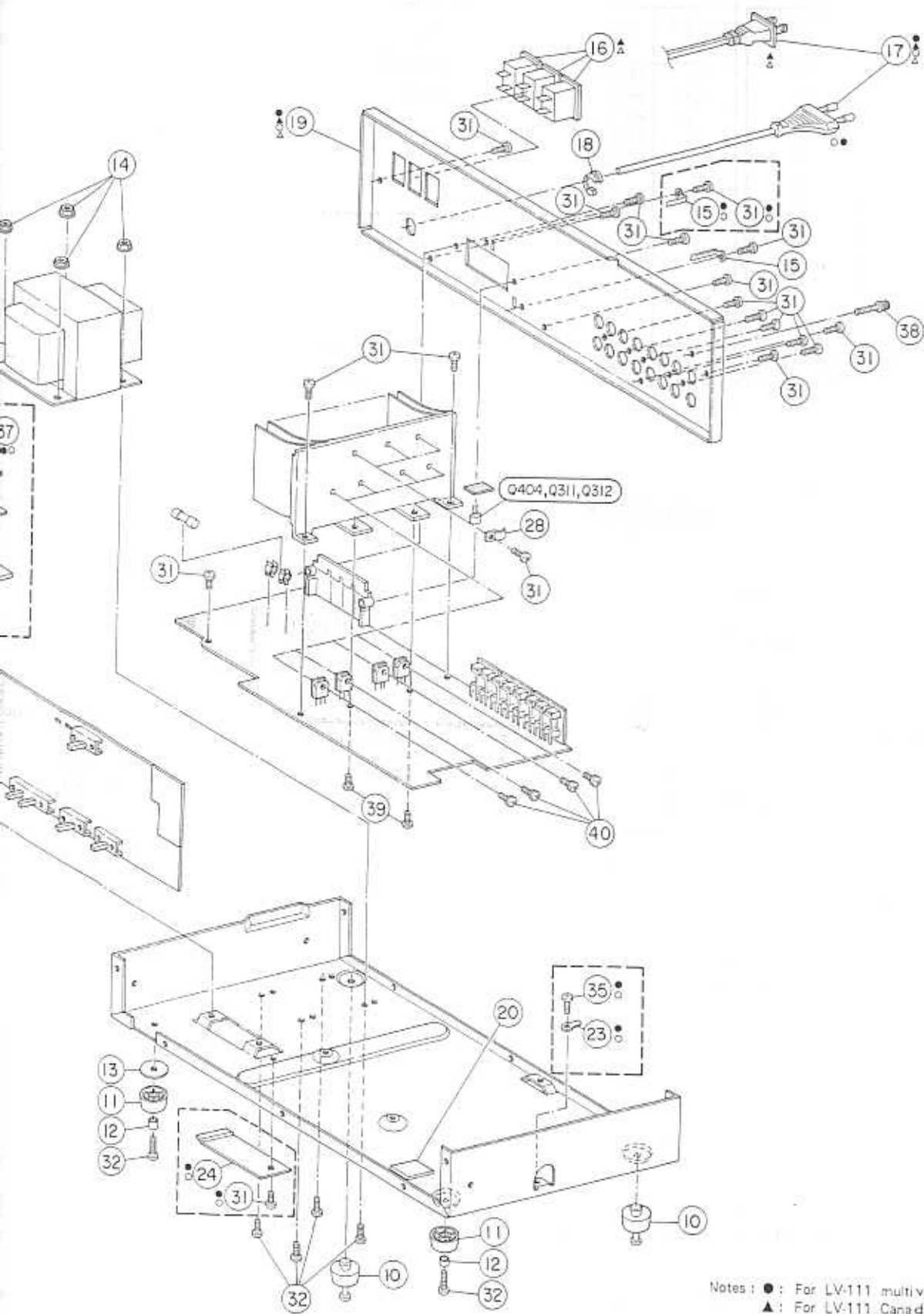

Notes : ● : For LV-111 multivoltage model (AD).
 ▲ : For LV-111 Canadian model (UQ).
 ○ : For LV-110 multivoltage model (AD).
 △ : For LV-110 Canadian model (UQ).
 Others : Common.

Packing Assembly Parts List

Symbol No.	Part No.	Description			Symbol No.	Part No.	Description		
●	101	56E04698S01	Carton, Packing			106	56E04698S02	Box, Snow, L	
▲	101	56E04698S01	Carton, Packing			107	56E04700S01	Bag, High Polyester	
○	101	56E04698S02	Carton, Packing			108	68P94789F06	Owner's Manual	
△	101	56E04698S02	Carton, Packing			▲	111	68P44370P63	Warranty Card
	105	56E04699S01	Box, Snow, R			△	111	68P44370P63	Warranty Card
						119	56E04783S01	Bag, Polyester	

Notes : ● : For LV-111 multivoltage model (AD), ▲ : For LV-111 Canadian model (UQ),
○ : For LV-110 multivoltage model (AD), △ : For LV-110 Canadian model (UQ), Others : Common.

Packing Method View

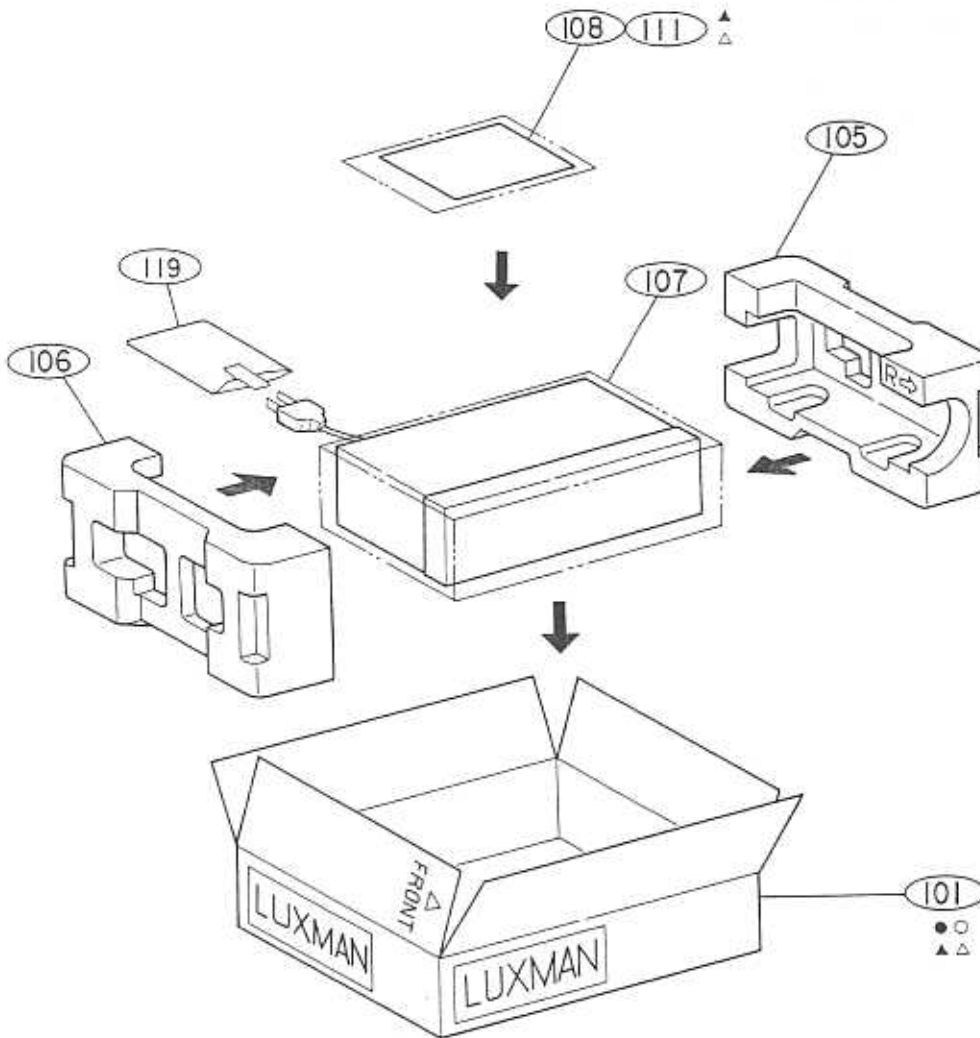

Semi-Conductor Lead Identifications

M5220L : IC101

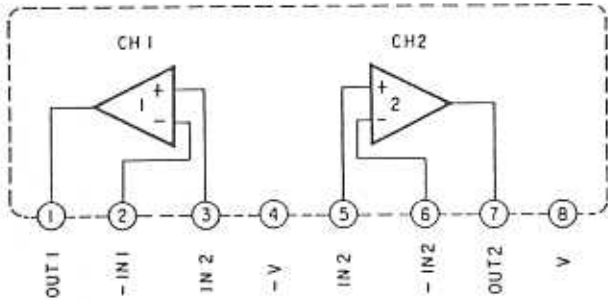
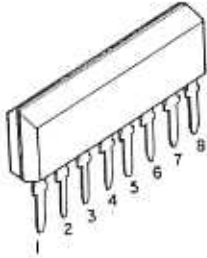

BA4558HT : IC201

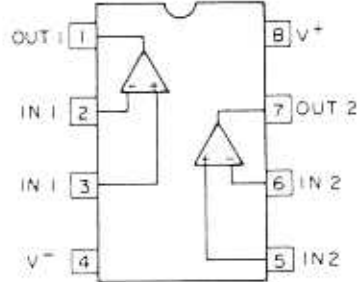
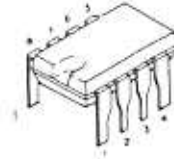

STK3042M-III : IC301

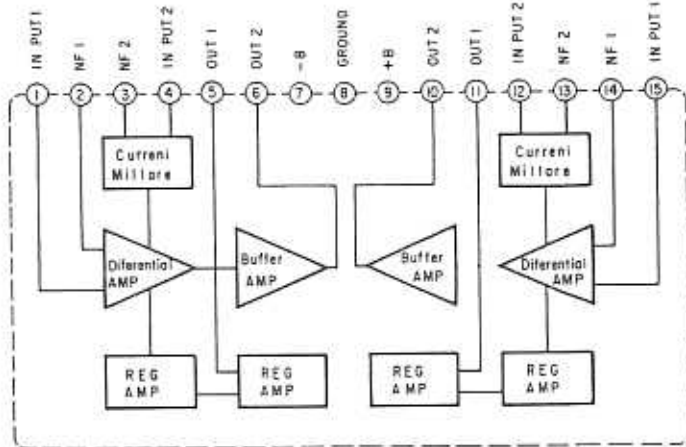
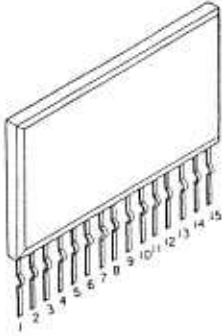

L78M15 : IC501

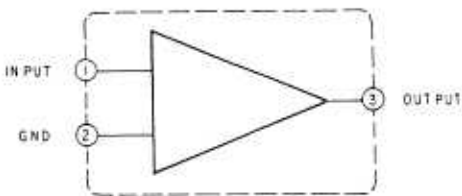

2SD600 : Q301, 302
2SB631 : Q303, 304



2SD1047 : Q305, 306
2SB817 : Q307, 308



2SA1015 : Q341, 342, 347, 348, 403,
2SC1815 : Q343~346, 401, 402, 405, 406
2SC2120 : Q407



Parts Layout on P.C. Boards and Wiring Diagram

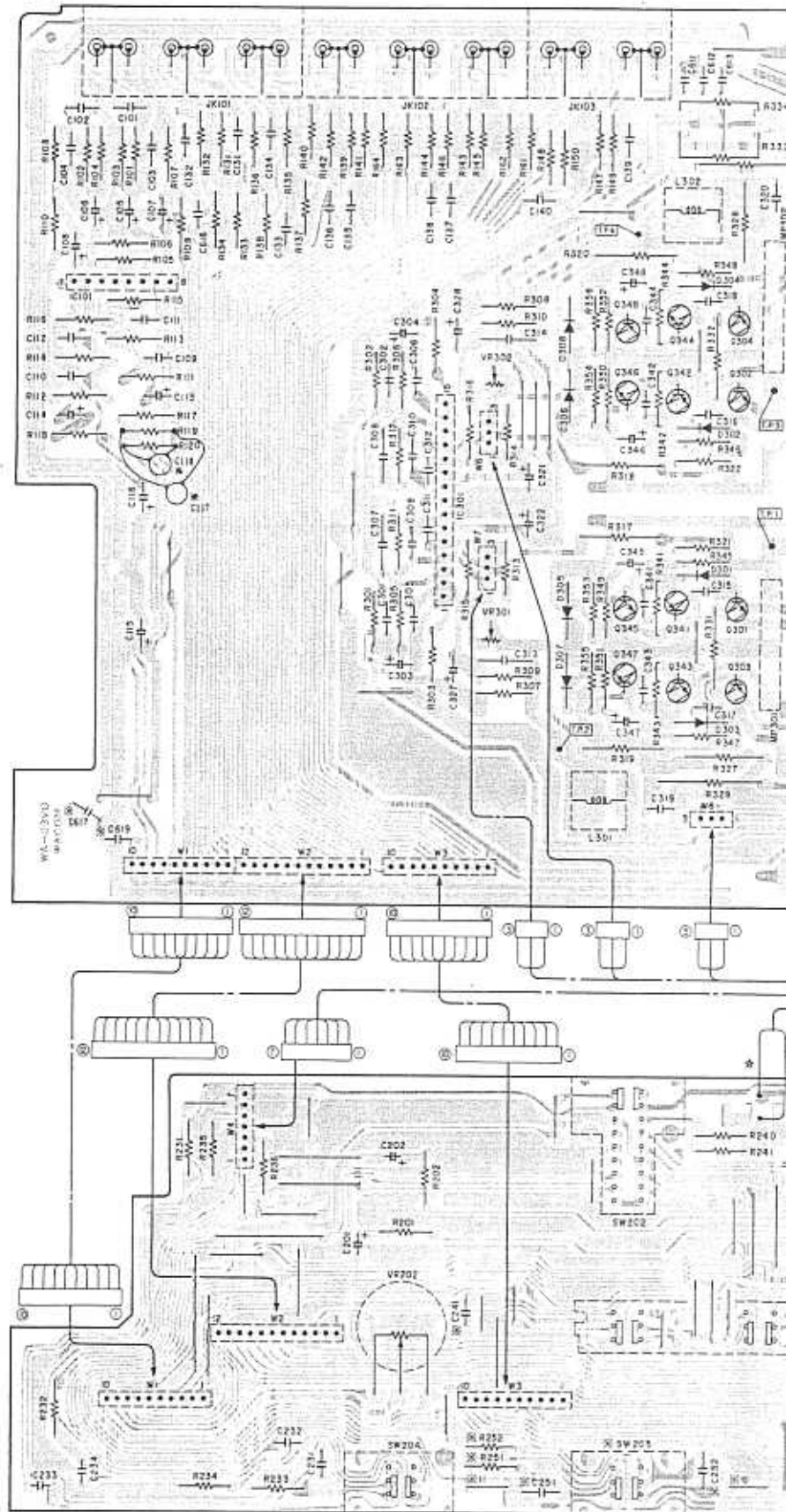

- BLU Blue
- GRN Green
- BLK Black
- GRY Gray
- WHT White
- RED Red
- BRN Brown
- ORG Orange
- YEL Yellow
- PNK Pink
- VIO Violet
- GRN/WHT Green/White
- GRY/WHT Gray/White
- GRY/YEL Gray/Yellow
- GRN/YEL Green/Yellow
- SHLD Shield

Main P.C. Board

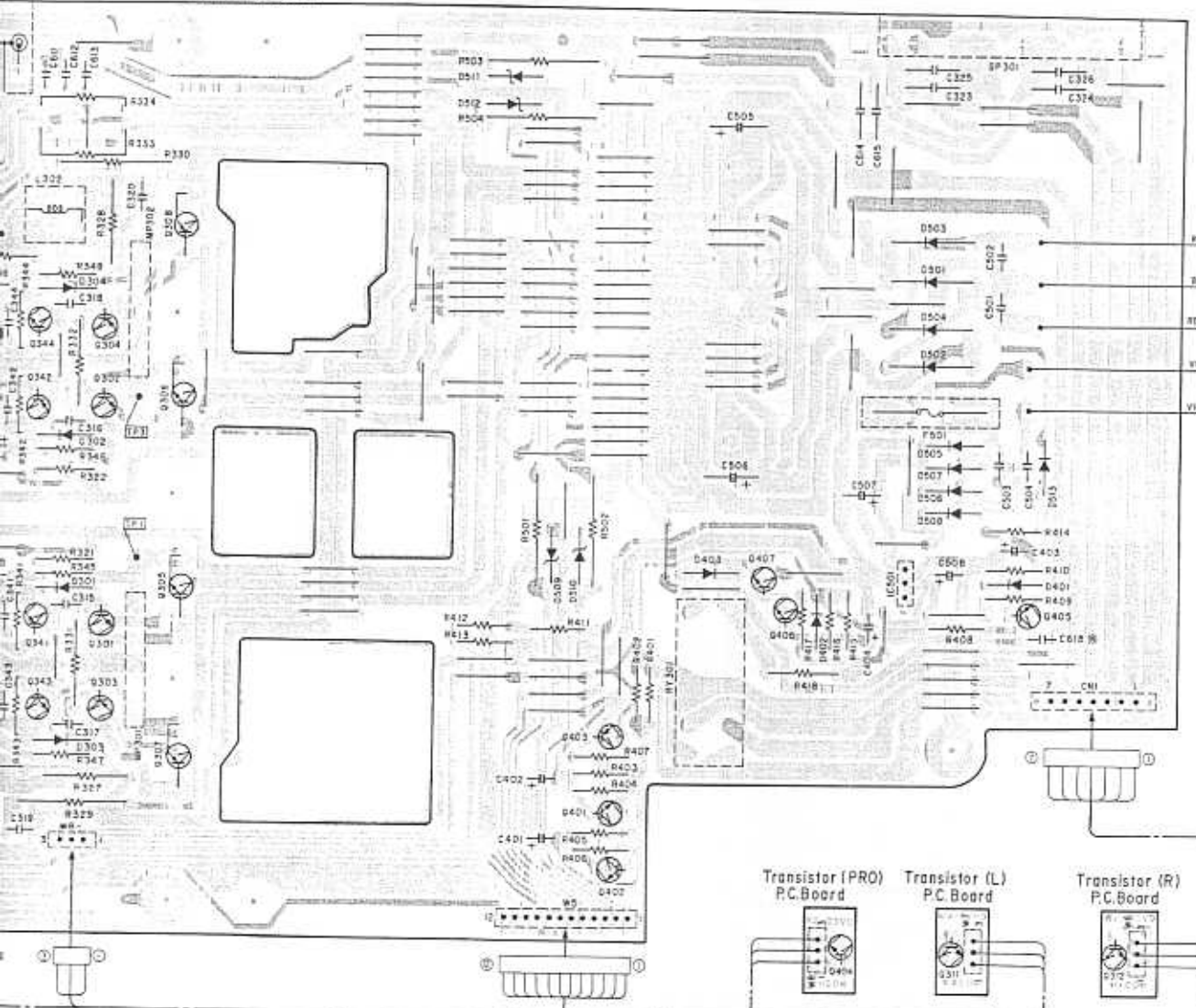

Power Switch P.C.

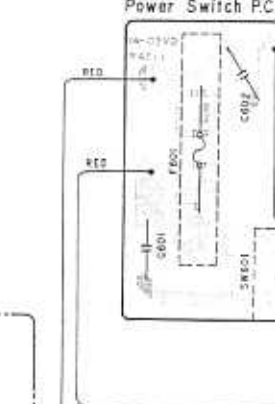

Fuse P.C. Board (AO Model Only)



Headphone P.C. Board

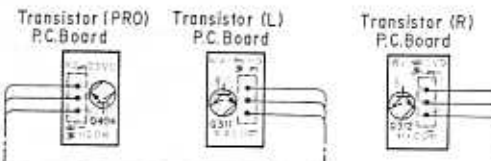
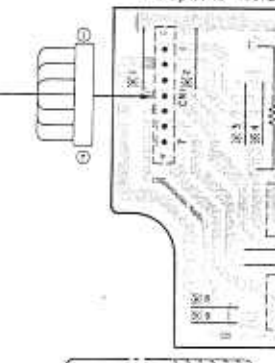

Function P.C. Board

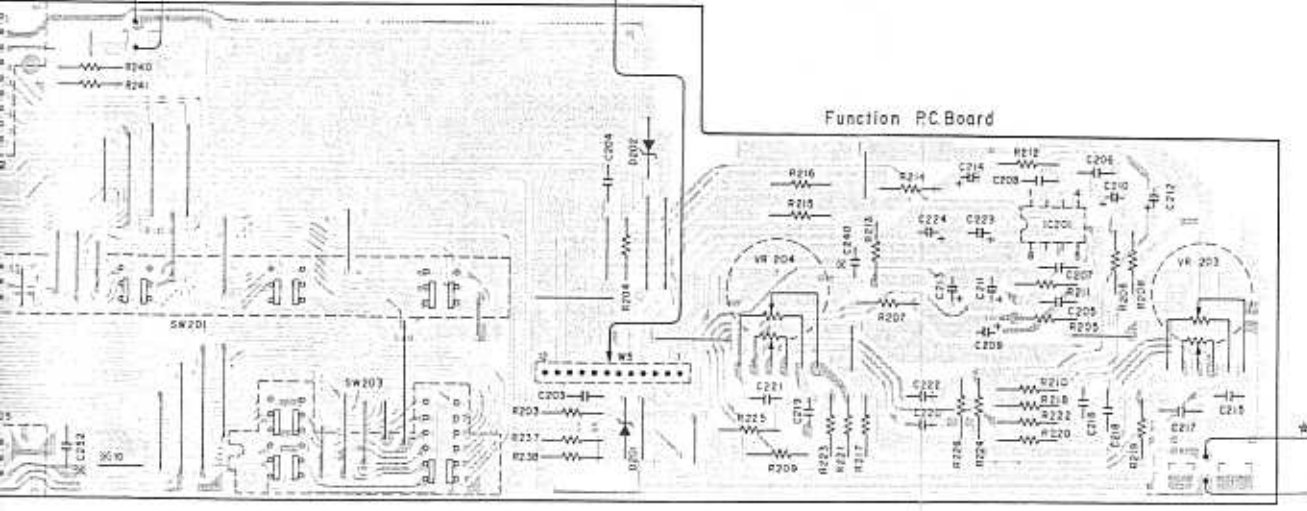

LED P.C. Board (1)

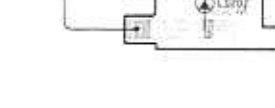

LED P.C. Board (2)

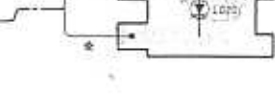

m

Main PC Board

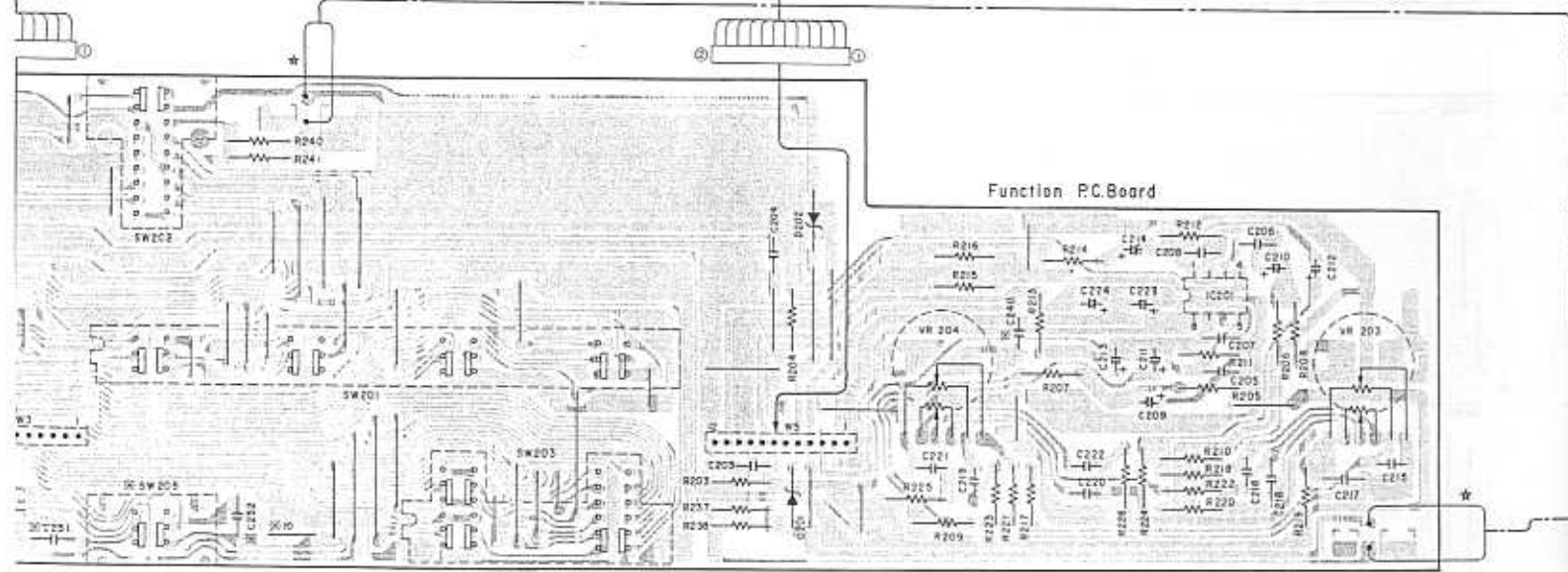
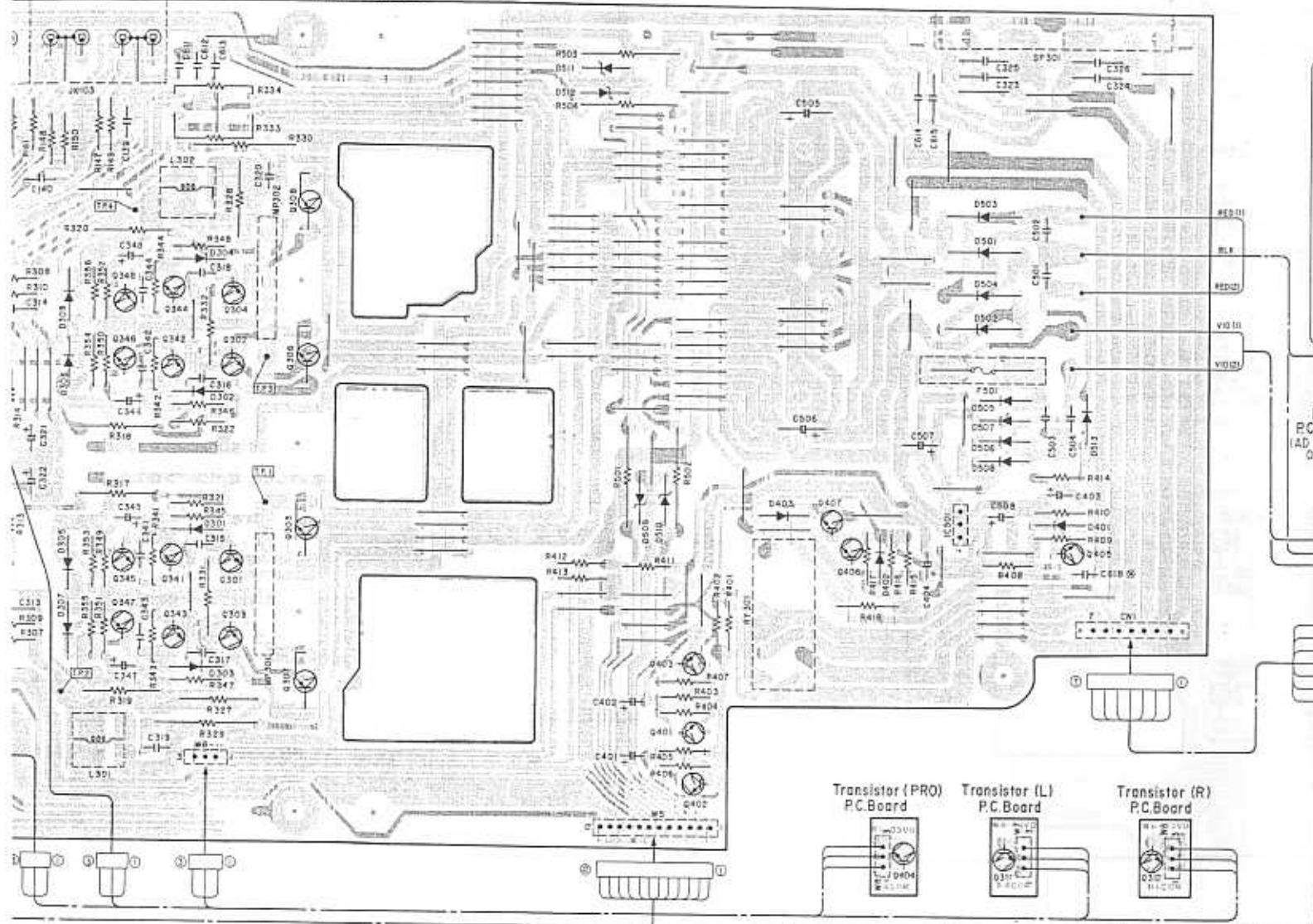

Parts Layout on P.C. Boards and Wiring Diagram

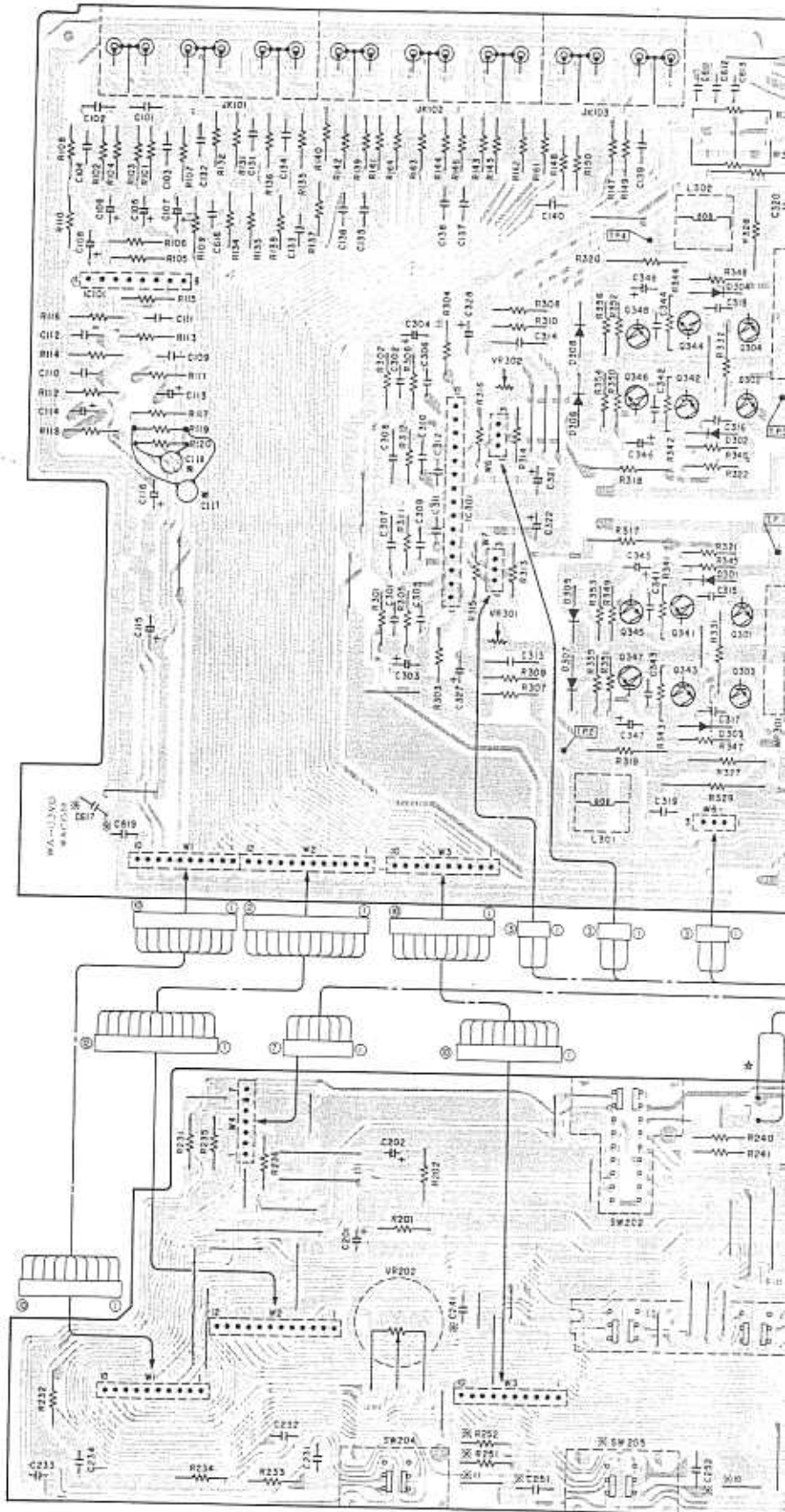

- BLU Blue
- GRN Green
- BLK Black
- GRY Gray
- WHT White
- RED Red
- BRN Brown
- ORG Orange
- YEL Yellow
- PNK Pink
- VIO Violet
- GRN/WHT Green/White
- GRY/WHT Gray/White
- GRY/YEL Gray/Yellow
- GRN/YEL Green/Yellow
- SHLD Shield

Main P.C. Board

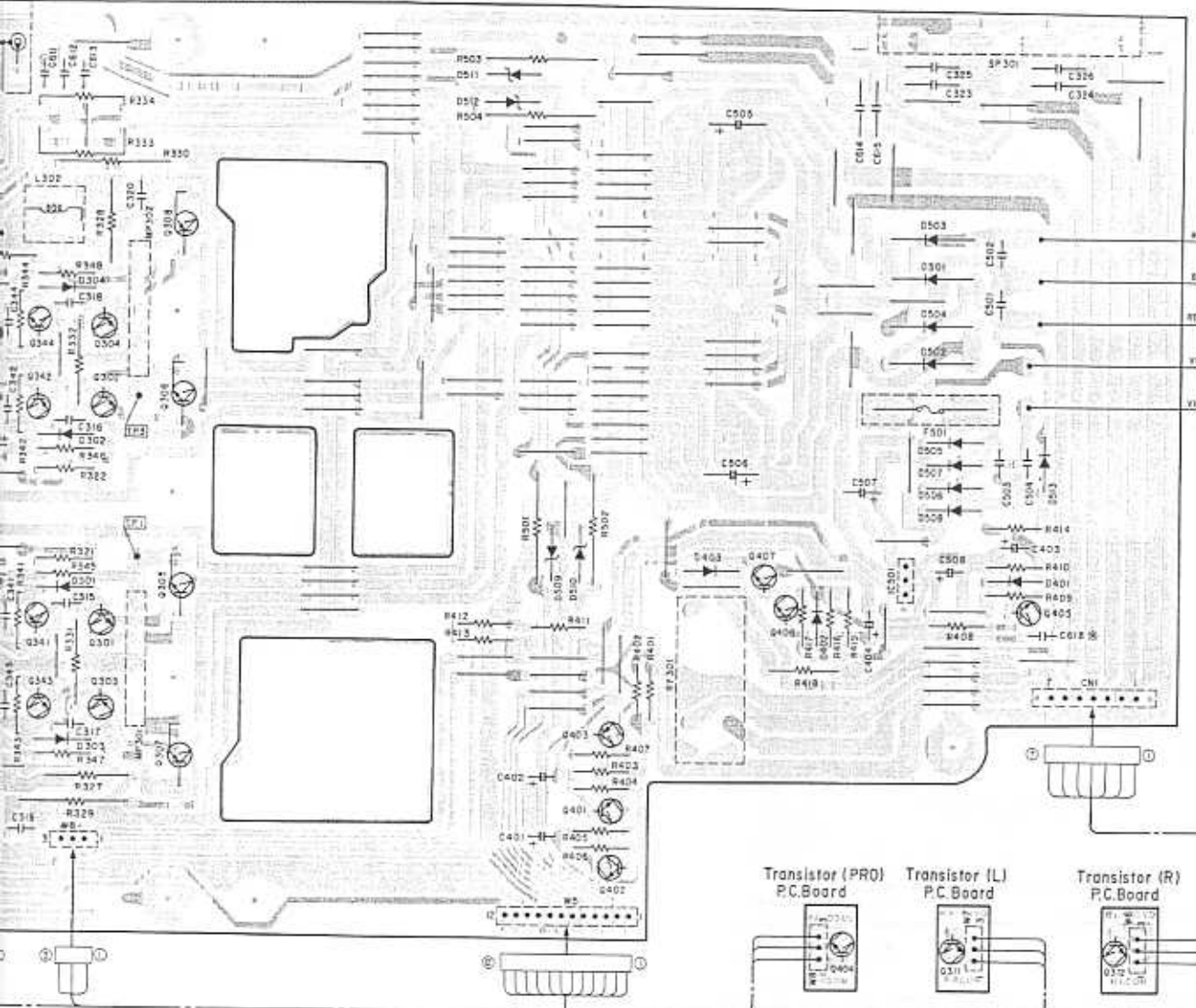

Power Switch P.C.



Fuse P.C. Board (AO Model Only)



Headphone P.C. Board

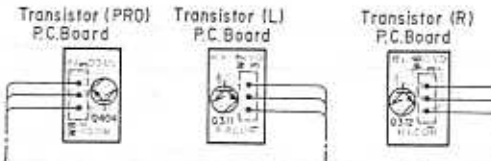
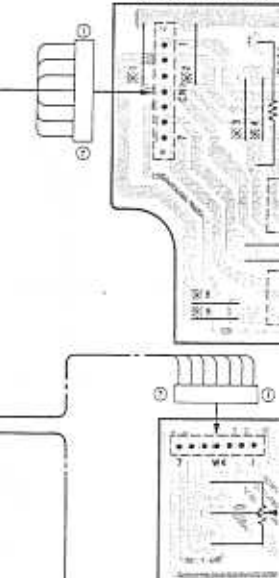

Function P.C. Board

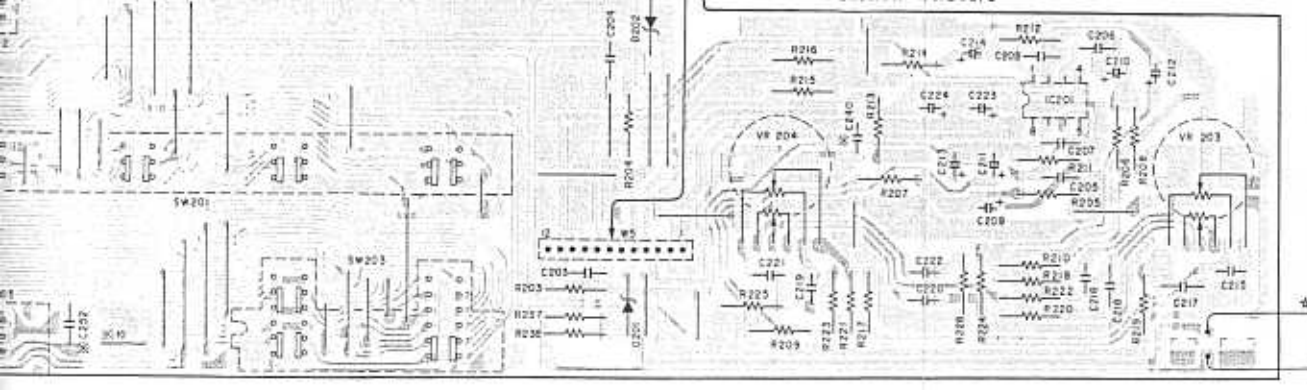

LED P.C. Board (1)

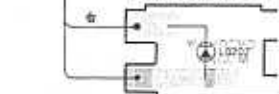

LED P.C. Board (2)

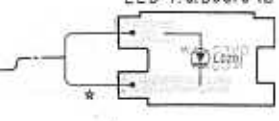

Schematic Diagram

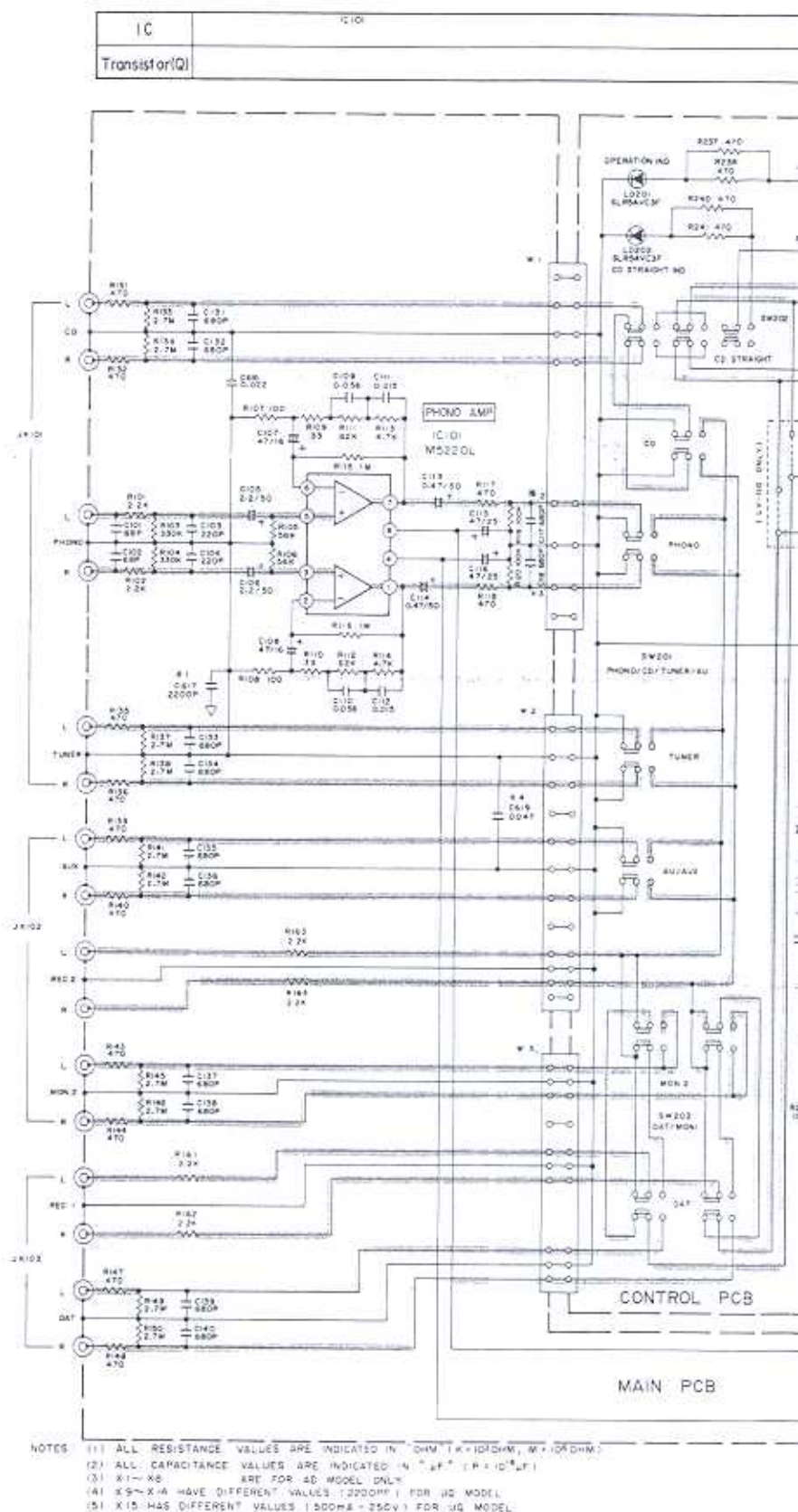

- NOTES
- (1) ALL RESISTANCE VALUES ARE INDICATED IN OHM (K=1000OHM, M=10000OHM)
 - (2) ALL CAPACITANCE VALUES ARE INDICATED IN P.F. (P=10⁻¹²F)
 - (3) X1-X8 ARE FOR 40 MODEL ONLY
 - (4) X9-X14 HAVE DIFFERENT VALUES (2200PF) FOR 40 MODEL
 - (5) X15 HAS DIFFERENT VALUES (500PF-350PF) FOR 40 MODEL

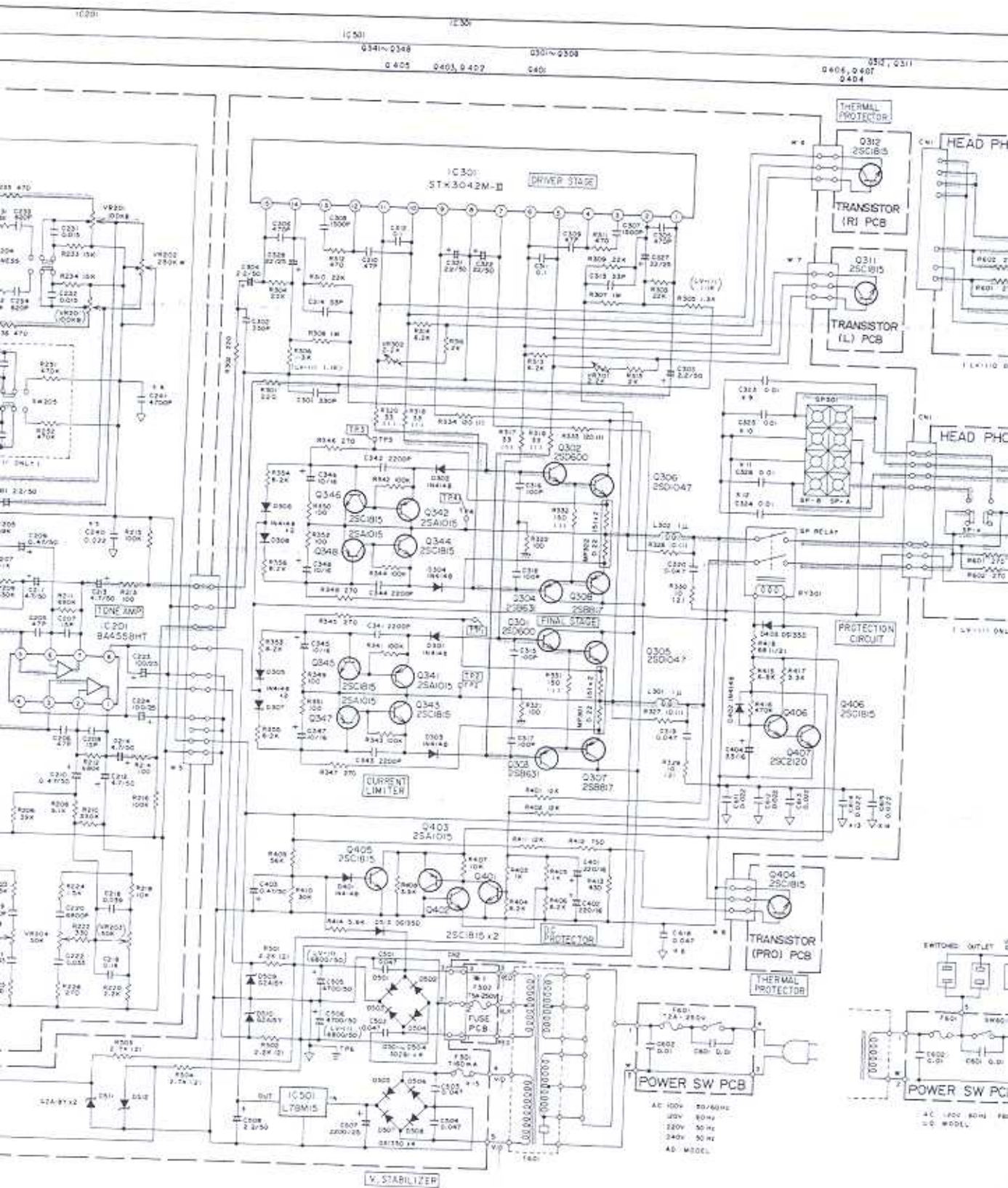

NOTES:

1. All resistance values are in ohms.
2. All capacitance values are in micro.

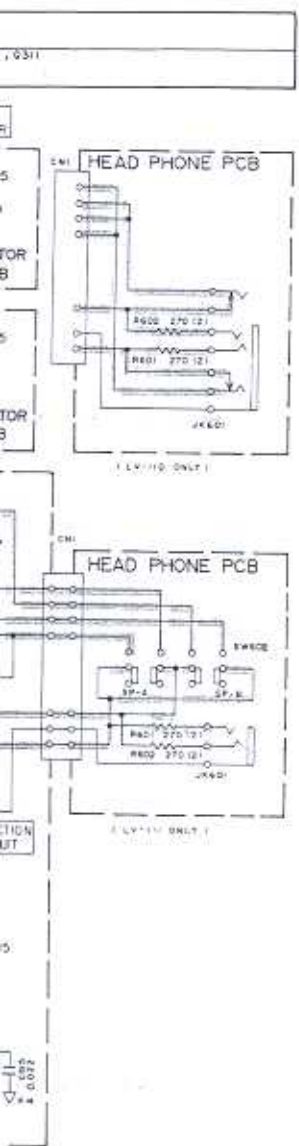

(Assume Conditions)
 • Power supply voltage: 220V AC
 • Measuring point reference: To ground
 • Relay circuit: Relay on

IC 1 8 1

1	-6.87V
2	10mV
3	50mV
4	-15.7V
5	50mV
6	50mV
7	-6.87V
8	15.7V

IC 2 6 1

1	10mV
2	80mV
3	80mV
4	-15.7V
5	87mV
6	87mV
7	10mV
8	15.7V

IC 3 0 3

1	-45mV	9	40.7V
2	-0.7mV	10	-1.1V
3	40.7V	11	-1.1V
4	39.4V	12	39.5V
5	-1V	13	49V
6	1V	14	-0.4mV
7	-0.28V	15	-0.2mV
8	0V		

IC 5 0 1

16	00V
22.7V	10V

	C	C	B
Q201	0V	0V	-1.1V
Q202	0.55V	0V	-1.1V
Q203	-0.59V	0V	-1.1V
Q204	-0.38V	0V	-1.1V
Q205	-0.3mV	42.5V	0.37V
Q206	-0.4mV	42.5V	0.37V
Q207	-1.2mV	-42.5V	-0.37V
Q208	-10.9mV	42.5V	-0.36V
Q209	0V	0V	-0.43V
Q210	0V	0V	-0.36V
Q211	1V	-6.8mV	0V
Q212	1V	0V	-1.1V
Q213	1V	0V	-1.1V
Q214	-1V	-6.8mV	-1.1V
Q215	-1V	0V	-1.1V
Q216	-1V	0V	-1.1V
Q217	0V	1V	-4.5mV
Q218	0V	1V	-0.6mV
Q219	0V	-1V	-10mV
Q220	0V	-1V	-10.2mV
Q401	0V	0.2V	-1.2mV
Q402	-0.2mV	0.2V	-1.2mV
Q403	0.2V	1.5mV	0.3V
Q404	0V	0V	0.3V
Q405	0V	0.2V	-2V
Q406	1.4mV	0.8mV	0.7V
Q407	0.7V	0.7V	1.4V

Ref No.	Model	LF-111 MΩ only ●	LV-111 Ω only ▲	LP-111 MΩ only ○	LV-110 Ω only △
W1	C107	2700pF	Not used	2700pF	Not used
W2	C107	470pF	Not used	470pF	Not used
W3	C118	100pF	Not used	100pF	Not used
W4	C219	0.247μF	Not used	0.247μF	Not used
W5	C240	0.221μF	Not used	0.221μF	Not used
W6	C241	4700pF	Not used	4700pF	Not used
W7	C242	2500 pA	Not used	2500 pA	Not used
W8	C513	0.247μF	Not used	0.247μF	Not used
W9	C223	0.01μF	2200pF	0.01μF	2200pF
W10	C225	0.01μF	2200pF	0.01μF	2200pF
W11	C226	0.01μF	2200pF	0.01μF	2200pF
W12	C227	0.01μF	2200pF	0.01μF	2200pF
W13	C514	0.022μF	2200pF	0.022μF	2200pF
W14	C515	0.022μF	2200pF	0.022μF	2200pF
W15	F501	100V 0.1A	100V 500mA	250V 0.1A	100V 500mA
W200	Substrate Switch	Substrate Switch	Not used	Not used	Not used
W202	SocketA, B Switch	SocketA, B Switch	Not used	Not used	Not used
W203	W204	470kΩ	470kΩ	Not used	Not used
W205	W206	1.1kΩ	1.1kΩ	1.1kΩ	1.1kΩ
W207	W208	0.27μF	0.27μF	Not used	Not used
W209	W210	1000μF	1000μF	4700μF	4700μF
W211	W212	250V 2A	100V 1.5A	250V 2A	100V 1.5A
W213	FJ211A4B-4	FJ211A4B-K	FJ211A4B-4	FJ211A4B-4	FJ211A4B-4

Resistance values are in ohms. K = 1,000
 Capacitance values are in microfarads. P = $\frac{1}{1,000,000}$

LV-111/LV-110